

6. MEASURES TO ACHIEVE FAUNA SENSITIVE ROADS

- 6.1 Overpass: Land Bridge.....6**
 - 6.1.1 Target species6
 - 6.1.2 Design specifications6
- 6.2 Overpass: Small Roads (dual purpose).....9**
 - 6.2.1 Target species 11
 - 6.2.2 Design specifications 11
- 6.3 Overpass: Cut and Cover Tunnel12**
 - 6.3.1 Target species 12
 - 6.3.2 Design specifications 13
- 6.4 Overpass: Canopy Bridge13**
 - 6.4.1 Target species 14
 - 6.4.2 Design specifications 14
 - a) Rope tunnel..... 15
 - b) Rope ladder 17
 - c) Single rope crossings 18
- 6.5 Overpass: Poles19**
 - 6.5.1 Target species 19
 - 6.5.2 Design specifications 19
 - a) Glider poles..... 19
 - b) Refuge poles..... 22
- 6.6 Underpass: Culvert25**
 - 6.6.1 Target Species.....25
 - 6.6.2 Design Specifications25
 - a) Design of structures for aquatic species.....26
 - b) Design of structures for amphibian species.....38
 - c) Design of structures for turtles.....40
 - d) Design of Structures for platypus.....41
 - e) Design of structures for terrestrial species42
 - f) Design of structures for bats.....52
- 6.7 Underpass: Tunnel.....54**
 - 6.7.1 Target species54
 - 6.7.2 Design specifications54
- 6.8 Underpass: Bridge55**
 - 6.8.1 Target species55
 - 6.8.2 Design specifications55







6.9	Non-structural mitigation: Canopy Connectivity	57
6.9.1	Target species.....	58
6.9.2	Design specifications	58
6.10	Non-structural mitigation: Local Traffic Management.....	60
6.10.1	Target species.....	60
6.10.2	Design specifications	60
a)	Signage and road markings	62
b)	Wildlife warning reflectors	64
6.11	Barriers: Fencing.....	64
6.11.1	Target species.....	64
6.11.2	Design specifications	65
a)	Fauna exclusion/ koala proof fencing	66
b)	Frog fencing	71
c)	Turtle fencing	75
d)	Cassowary fencing.....	75
6.12	Barriers: Chemical Repellents	78
6.12.1	Target species.....	78
6.12.2	Design specifications	78
6.13	Barriers: Perching Deterrents	78
6.13.1	Target species.....	78
6.13.2	Design specifications	78
6.14	Habitat enhancement: Frog Ponds.....	81
6.14.1	Target species.....	81
6.14.2	Design specifications	81
6.15	Habitat enhancement: Nest Boxes	82
6.15.1	Target species.....	82
6.15.2	Design specifications	82
a)	Arboreal species	82
b)	Bats	85
6.16	Habitat enhancement: Artificial Shelter Sites	86
6.16.1	Target species.....	86
6.16.2	Design specifications	86
a)	Pavers and roof tiles	87
6.17	Considerations which influence effectiveness of fauna structures	87
6.17.1	Aspects that positively influence rates of fauna structure use.....	87
a)	Vegetation management in vicinity of structures	87
b)	Density of fauna mitigation structures.....	88
c)	Location of fauna mitigation structures	88
d)	Integration into the surroundings	88





- e) Table drain management.....88
- 6.17.2 Aspects that negatively influence the rates of fauna structure use89
 - a) Table drain management.....89
 - b) Vegetation management.....89
- 6.18 Other methods that influence the effectiveness of fauna structures.....89**
 - 6.18.1 Education89
 - 6.18.2 Lighting89
 - a) Vehicle lights.....90
 - b) Street lighting93
 - 6.18.3 Noise94
 - a) Elevation of the road surface, and cuts and fills.94
 - b) Solid barriers.....94
 - c) Vegetative barriers.....97
 - d) Road surface.....98
 - 6.18.4 Design Speed98
 - 6.18.5 Road Safety Barriers98



6 MEASURES TO ACHIEVE FAUNA SENSITIVE ROADS

- This section of the manual describes the purpose of fauna mitigation measures and the detailed descriptions of each measure.
- The content and directions in the manual are considered as best case scenario outcomes. Based on this, the aim for fauna sensitive road design should be to produce the best overall, locally relevant outcome, considering site specific limitations.
- There is a great detail of ambiguity on the definition of structure types. In this manual the definitions for structure types have been adopted from van der Ree *et al.* (2007) for consistency.
- For a more detailed review see Hayes (2006).

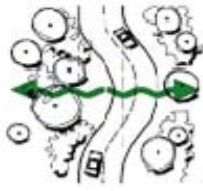
Table 6.0.1 Definitions of options aimed at achieving fauna sensitive road design (adopted from van der Ree *et al.* 2007).

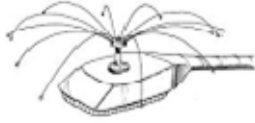
Title		Description
OVERPASS		Passage of animals above the road
Land bridge		A bridge extending over a road, typically 20 to 70 metres wide. The bridge is covered in soil, planted with vegetation and enhanced with other habitat features (for example, logs, rocks and so on). Also known as an eco-duct or wildlife bridge.
Overpass (small roads)		A narrow bridge (not hour-glass shaped) above a major road, which allows human or vehicular access across the minor road. The road on the overpass is typically a minor road, which may be unsealed or a single lane. Additional areas adjacent to the road may be utilised for fauna movement.
Cut and Cover Tunnel		The road passes below ground level through a tunnel with the area above available for revegetation and use by some fauna species.
Canopy bridge		A rope or pole suspended above the traffic, either from vertical poles or from trees. Used by arboreal and scansorial (climbing) species.
Pole		Vertical poles placed in the centre median, on the road verge or on an overpass to provide species that glide with an intermediate landing and multiple launch opportunities. Alternative designs can be utilised to provide refuge from predators for tree-kangaroos or other arboreal species.
UNDERPASS		Passage of animals below the road
Culvert		Square, rectangular or half circle in shape and may be purpose built for fauna passage or water drainage, or a combination of both. They are typically pre-cast concrete cells, or arches made of steel.

Title	Description
Tunnel	 <p>Typically round pipes of relatively small diameter (for example, less than 1.5 metres in diameter). May also be known as an eco-pipe.</p>
Passage below bridge	 <p>A structure that maintains the grade of the road or elevates the traffic above the surrounding land, allowing animals to pass under the road. Facilitates water drainage or the movement of local human traffic and secondarily facilitates fauna passage. Vegetation clearing can also be minimised (clearing only required for bridge piers or pylons) and allow natural vegetation to grow under the infrastructure.</p>
NON-STRUCTURAL MITIGATION	
Canopy connectivity	 <p>Items that facilitate natural permeability</p> <p>The linear clearing is kept sufficiently narrow to allow the tree canopy to remain continuous above the road or where discontinuous, sufficiently narrow to allow gliders (and other volant species) to safely traverse.</p>
Local traffic management	 <p>Devices to reduce the speed, volume of traffic or increase awareness of fauna, for example, road closures, chicanes, crosswalks, lighting, signage.</p>
BARRIERS	
Fencing	 <p>Structures that create a barrier to animals entering the road corridor or using road furniture</p> <p>Stops animals crossing the road surface, and is used as an integral component encouraging animals towards safe crossing passages.</p>
Chemical Repellents	 <p>Used on a temporary basis (for example, when a breach in a fauna exclusion fence occurs) to discourage animals from approaching the road.</p>
Perching Deterrents	 <p>Prevents birds perching on top of road furniture.</p>
HABITAT ENHANCEMENT	
Structures that improve the functionality of the road corridor and surrounding areas for fauna species	

	Title	Description
Frog Ponds		Aimed at re-creating frog breeding opportunities
Nest Boxes		Provides replacement nesting and roosting opportunities for fauna when tree hollows are removed.
Artificial Shelter Sites		Non-natural material placed within the road corridor or adjacent areas to restore or replace lost habitat.

Fauna mitigation structures are designed with a specific purpose in a specific environment. As such, the drawings and designs for fauna mitigation structures vary. The following are general descriptions, functions and design considerations for fauna mitigation measures outlined in the above table, with the information provided to be used as a guide only.

Generally, the integration of anthropocentric measures (reducing speed limits, raising awareness) with fauna sensitive structures (providing crossing structures, escape routes from roads and discouraging road use by fauna) results in the retention of habitat connectivity and lowers road kill faster and is more effective than implementing individual mitigation measures (van der Ree *et al.* 2007).

General factors to consider which influence the success of structures:

- Dimensions;
- Openness;
- Location;
- Habitat quality;
- Connectivity with wildlife corridors;
- Features of passage approach;
- Presence of furniture within the passage (logs, ropes, vegetation cover, and so on);
- Fencing;
- Period of time that structure has been available for usage; and
- Ability to view habitat on the other side of the road (Finegan 2004).

All of these factors must be considered to ensure the success of the proposed fauna mitigation measure as it is costly to upgrade/modify structures after the road has been constructed.

- Fauna mitigation structures should be considered where:
 - A habitat, community or species is or is planned to be 'significantly damaged' by the presence of a road.
 - Species vulnerable to impacts of barriers and traffic are located near a road.
 - Habitat connectivity is reduced, primarily by infrastructure.
 - The most appropriate mitigation measure is a fauna crossing.
 - The road is fenced (PIARC 2007).
 - A section of the road has a high fauna roadkill rate.

- The road crosses a regular fauna passage.
- When installing a fauna mitigation structure consider:
 - Target species (see Table 6.0.2).
 - Natural and existing fauna pathways.
 - Place fauna structures as close as possible to these pathways.
 - Access to structure.
 - Future land development may decrease the effectiveness or use of the installed structure.
 - Provision of canopy connectivity.
 - The presence of canopy connectivity has been proven to positively affect the use of structures.
 - Topography, as highest species diversity usually occurs in hilly terrain.
 - Suitability and purpose of vegetation.

Table 6.0.2 Suitability of different types of fauna structures for a selection of commonly addressed species or groups of species.

	Overpasses				Underpasses			Non-structural mitigation		Barriers	
	Land bridge	Overpass (small roads)	Canopy bridge	Poles	Culvert	Tunnel	Passage below bridge	Canopy connectivity	Local traffic management	Fencing	Chemical repellents
Fishes	-	-	-	-	○	○	●	-	-	-	-
Frogs	●	○	-	-	○	○	●	○	-	●	-
Mammals: macropods	●	●	-	●	○	-	○	-	○	●	?
Mammals: arboreal species	●	●	●	●	○	○	○	●	○	●	?
Mammals: koalas	●	●	-	●	●	○	○	-	○	●	?
Mammals: platypus	-	-	-	-	○	○	●	-	-	?	-
Mammals: bats/flying foxes	●	●	-	-	-	-	●	●	-	-	-
Mammals: small-size	●	●	-	○	●	●	●	-	○	●	?
Birds: flying	●	●	-	-	-	-	○	-	-	-	-
Birds: non-flying	●	●	-	-	○	-	●	-	○	●	?
Reptiles: snakes and lizards	●	○	-	-	○	○	●	-	-	-	-
Reptiles: turtles	●	○	-	-	●	●	●	-	○	○	-
Invertebrates: insects and spiders	●	○	-	-	●	●	●	-	-	-	-

- optimal solution
- can be used with some adaptation to local conditions
- unsuitable
- ? unknown, more research required

6.1 Overpass: Land Bridge

A land bridge is a bridge which extends over a road, typically between 20 to 70 metres wide. The bridge is covered in soil, planted with vegetation and enhanced with other habitat features (for example, logs, rocks and so on) (Figures 6.1.1 to 6.1.3). It is also known as an eco-duct or wildlife bridge. Refer to Section 9.2: Case Studies: Compton Road, Brisbane City Council for an example project.

6.1.1 Target species

- All species, excluding aquatic.



Figure 6.1.1 Land bridge at Compton Road, Brisbane (Robinson-Wolrath 2007). Rope ladder installed to cater for arboreal species.

6.1.2 Design specifications

- Width:
 - Dependent on the purpose, surrounding topography, environment and target species, for example, birds require a wider bridge.
 - Existing land bridges range from eight to 870 metres in width.
 - 50 metres or greater:
 - will be utilised by the widest variety of species; and
 - animals will exhibit natural behaviour.
 - A narrower land bridge will be used by some species if designed appropriately.
- Location of land bridge:
 - Animal movement hotspots.
 - Consider all animals, including birds, invertebrates, bats and reptiles.
 - In high cuts to align with the natural ridge contours, where possible.
- Depth of Soil:
 - Dependent on planned vegetation.
 - Acts as a limiting factor to vegetation height.
 - Indication of soil depth required for specified groups:

- Grass: 300 mm
- Shrubs: 600 mm
- Trees: 1.5 – 2 metres

- Vegetation considerations:
 - Native to the area and provide food sources and habitat requirements for target species (for enticement purposes).
 - Choose planting which will attract target species to the structure.
 - Fast growing local grasses (and other palatable species) that provide a food source are ideal for attracting macropods.
 - Flowering and seeding plants serve as attractants to birds.
 - Maintain remnant mature vegetation leading up to the bridge abutments to encourage early use of the fauna structure and maintain invertebrate populations.

Ground covers suitable for small mammals, reptiles and invertebrates are:

- Wood and bark pulp;
- Leaf litter near and around planted vegetation; and
- Large logs placed in a mosaic fashion (Figure 6.1.3).

A moderate density of leaf litter in various stages of decomposition to cover 70-80% of the ground layer of fauna structures will encourage invertebrate species use.

For species with roosting or resting requirements (for example, gliders and koalas) provide sufficient number of trees to ensure there are adequate options to allow them to change trees at least once every 24 hours.

- Furniture:

Glider poles (where appropriate), boulders, rocks, logs provide opportunities for a broad range of species.

- Compliance with standard bridge clearance is required (Queensland Department of Main Roads 2005a).
- Ensure vegetated approach embankments to elevated land bridges are formed to a gentle 1:3 gradient, when required.
- Use a natural material base on land bridge (see 'Vegetation Considerations' above).
- Construct land bridge so macropods cannot see the traffic or headlights passing on the road beneath. Edges should be lined with high, wooden or blocked out exclusion fences to minimise noise and visual disturbance.
- Prohibit vehicle access by placing structures at either end, such as large boulders or guard rails.
- Although some countries prefer a few larger land bridges, it has been found that a greater number of small land bridges are more beneficial.

Advantages

- Provides a more natural crossing for fauna, particularly disturbance-sensitive species.
- Is utilised by a wide range of terrestrial species, including bats, birds, butterflies.
- Maintains genetic diversity through habitat and population connectivity.
- Provides a new habitat.
- Proven to provide a guiding-line function, encouraging birds to cross roads at safe crossing points.
- Encourages community and tourist interest in fauna crossings.

Disadvantages

- Success is dependent on several variables (for example, width, fauna exclusion fencing, vegetation, light, noise disturbance, suitability of vegetation, provision of artificial shelter sites and minimised human disturbance).
- Is costly.
- No standard design principles have been established in Australia.
- Must provide a variety of furniture types to cater for all of the target species.
- Has the potential to have a large disturbance footprint in order to establish approaches to and supports for the structure.
- Requires fencing to direct species to structure. This may not always be beneficial in otherwise undisturbed areas.
- May occur within the home range of a limited number of individuals constraining access for territorial species.

Maintenance Requirements:

- At least a yearly major maintenance.
- Ensure revegetation has established and is similar to existing, surrounding vegetation, where possible.
- Maintain furniture.



a) Cross section view

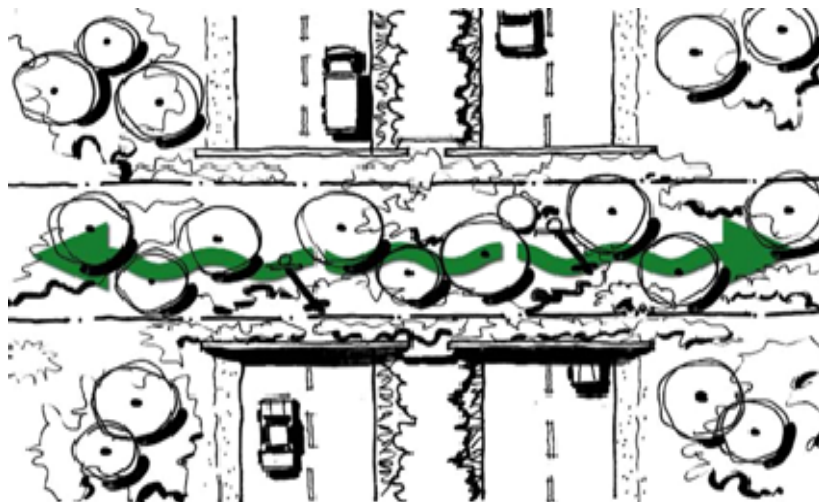

b) Plan view

Figure 6.1.2 Land bridge designed to accommodate a wide variety of species, including arboreal species as indicated by the presence of glider poles.



Figure 6.1.3 Vegetation and habitat structures provided for reptiles on the Compton Road land bridge (Scott 2007).

6.2 Overpass: Small Roads (dual purpose)

A small road (dual purpose) is a bridge above a major road, which is narrow (not hour-glass shaped) and allows human access across the road (Figures 6.2.1 and 6.2.2). The road on the overpass is typically a minor road, which may be unsealed and may be a single lane.

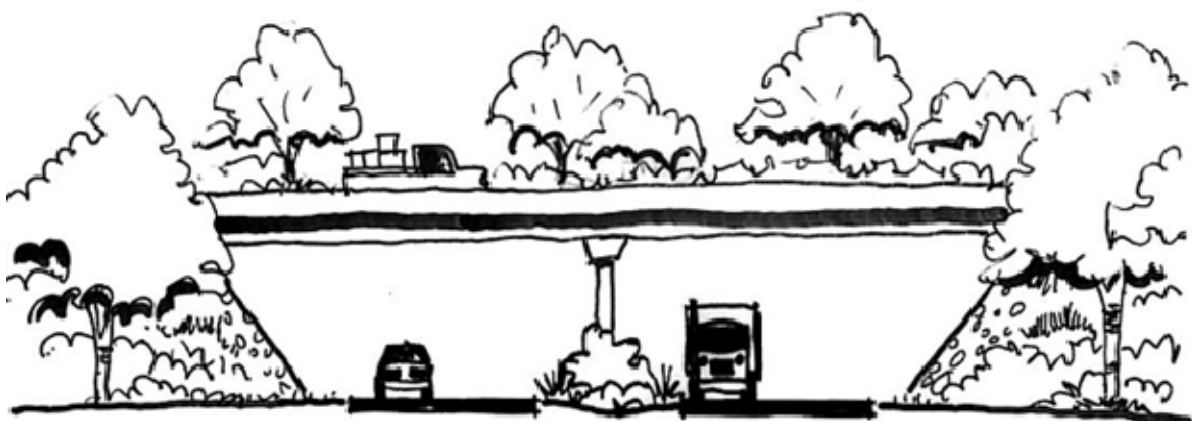

a) Cross-sectional view

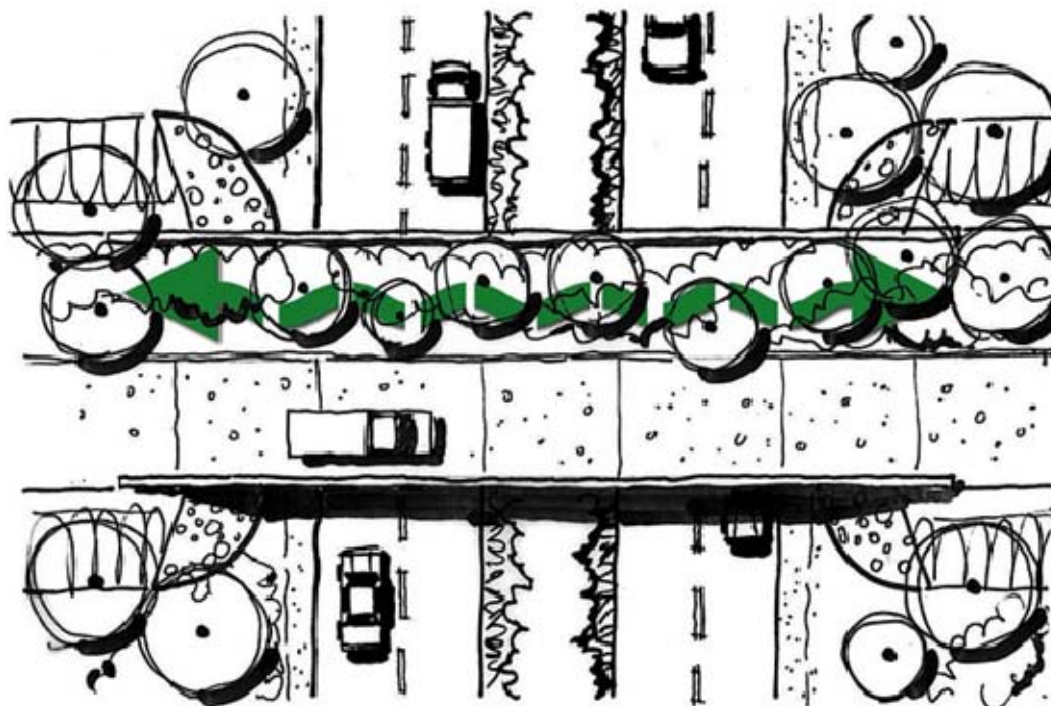

b) Plan view

Figure 6.2.1 Optimal design of a dual purpose overpass with a dedicated fauna-crossing section.

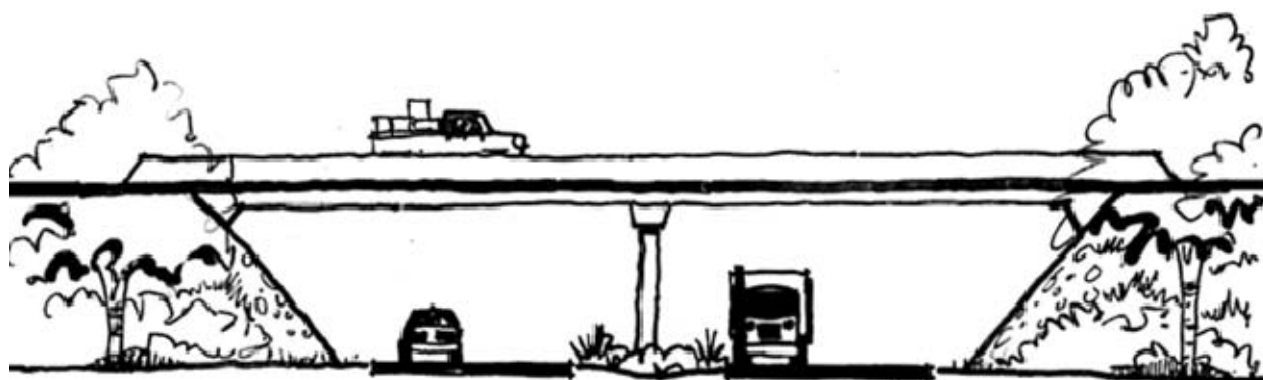

a) Cross-sectional view

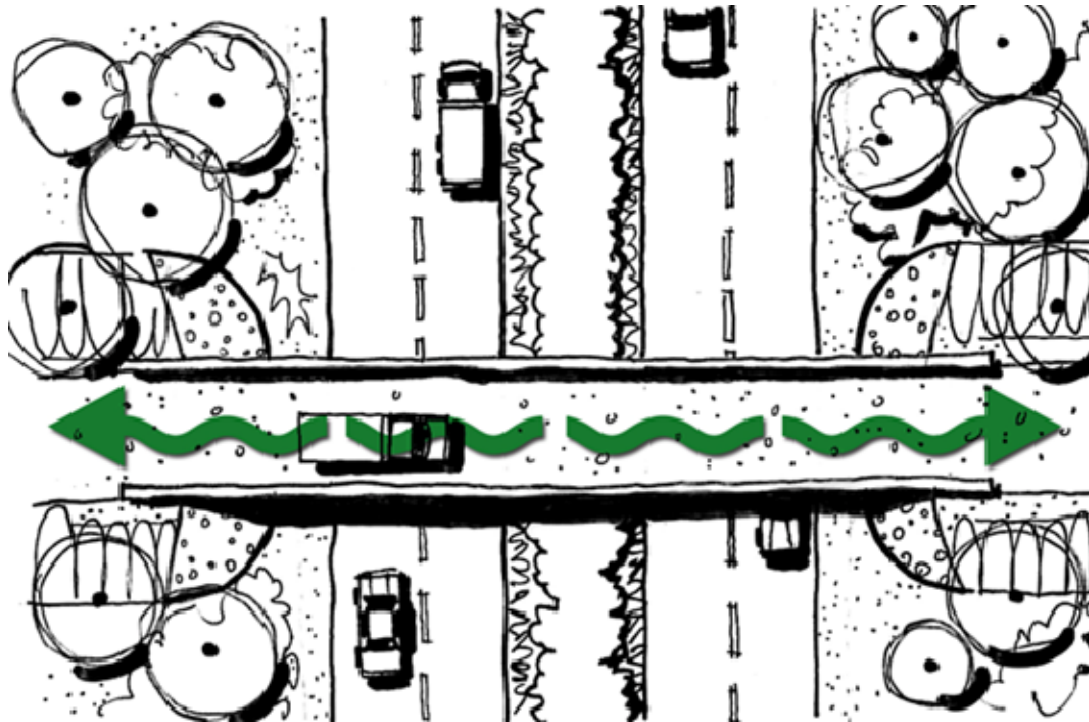

b) Plan view

Figure 6.2.2 Less optimal dual purpose overpass with fauna and local traffic sharing the complete structure.

6.2.1 Target species

- All species, excluding aquatic.
- Less suitable for highly sensitive species due to the likely impact of human disturbance.

6.2.2 Design specifications

- Ensure a section solely dedicated to fauna movement.
 - Width of approximately eight metres but will be dependent on the target species concerned.
- Road crossing should be a low speed environment.
- Drainage from the fauna crossing section shall be adequately designed to ensure no negative effects on the road crossing area.
- The structure is usually 'tanked' (waterproofed) and geofabric is utilised to provide a barrier between the soil, plants and the bridge structure.
- Furniture should be constructed to encourage use by target species. For example, rocks, boulders, leaf litter, glider poles, rope bridges.
- Fencing should be considered to exclude humans and vehicles from the fauna crossing section.
 - Fencing can be a combination of fauna exclusion fencing and solid wooden fencing to block out the impact of traffic and street lights on nocturnal fauna (refer to Section 6.18.2: Lighting).

Advantages

- Provides a more natural crossing for fauna than culverts.
 - May be utilised by a wide range of terrestrial species including bats, birds, butterflies.
- Likely to maintain a minimum level of genetic diversity through a degree of habitat and population connectivity.

- Provides a new habitat.
- Encourages community and tourist interest in fauna crossings.
- A cost-effective means to provide both fauna crossing opportunities and vehicular/pedestrian traffic.

Disadvantages

- Success is dependent on several variables (for example, width, fauna exclusion fencing, vegetation, light and noise disturbance).
- No standard design principles have been established in Australia.
- Must provide a variety of furniture types to cater for all of the target species.
- Has the potential to have a large disturbance footprint in order to establish approaches to and supports for the structure.
- Requires fencing to direct species to the structure. This may not always be beneficial in otherwise undisturbed areas.
- May occur within the home range of a limited number of individuals constraining access for territorial species.

Maintenance Requirements:

- At least a yearly major maintenance.
- Ensure that revegetation has established and is similar to existing, surrounding vegetation, where possible.
- Ensure vegetation does not cause any safety issues for the adjacent road.
- Maintain furniture.

6.3 Overpass: Cut and Cover Tunnel

The road passes below ground level through a tunnel, with the area above available for revegetation and use by some fauna species (Figure 6.3.1).



Figure 6.3.1 A cut and cover tunnel.

6.3.1 Target species

- All species, excluding aquatic.

6.3.2 Design specifications

Refer to Section 6.1: Overpass: Land Bridge for relevant concepts and design specifications.

- Each site must be assessed (according to factors such as topography, geology and grade) to determine suitability.
- At least 1.5 metres of soil is required on top of structure to enable revegetation with tree species.

Advantages

- Provides a more natural crossing for fauna as it is a continuation of the existing landscape.
- May be utilised by a wide range of terrestrial species including bats, birds, butterflies.
- Maintains genetic diversity through natural habitat and population connectivity.
- Encourages community and tourist interest in fauna crossings.
- Is ideal for an at-grade fauna crossing.
- Disturbance can be minimised as construction may occur under the dedicated fauna crossing in the form of a tunnel.
- Unnecessary to provide additional furniture to encourage use by fauna, as area above road can be revegetated.

Disadvantages

- Success dependent on several variables (for example, width, fauna exclusion fencing, vegetation, light and noise disturbance).
- Expensive.

6.4 Overpass: Canopy Bridge

A canopy bridge is a rope or pole suspended above the traffic, either from vertical poles or from trees to provide canopy connectivity (Figure 6.4.1). This structure is used by arboreal and scansorial (climbing) species (Figure 6.4.2).



Figure 6.4.1 Canopy bridges (ladder and box) over Palmerston Highway, North Queensland (Scott 2007).

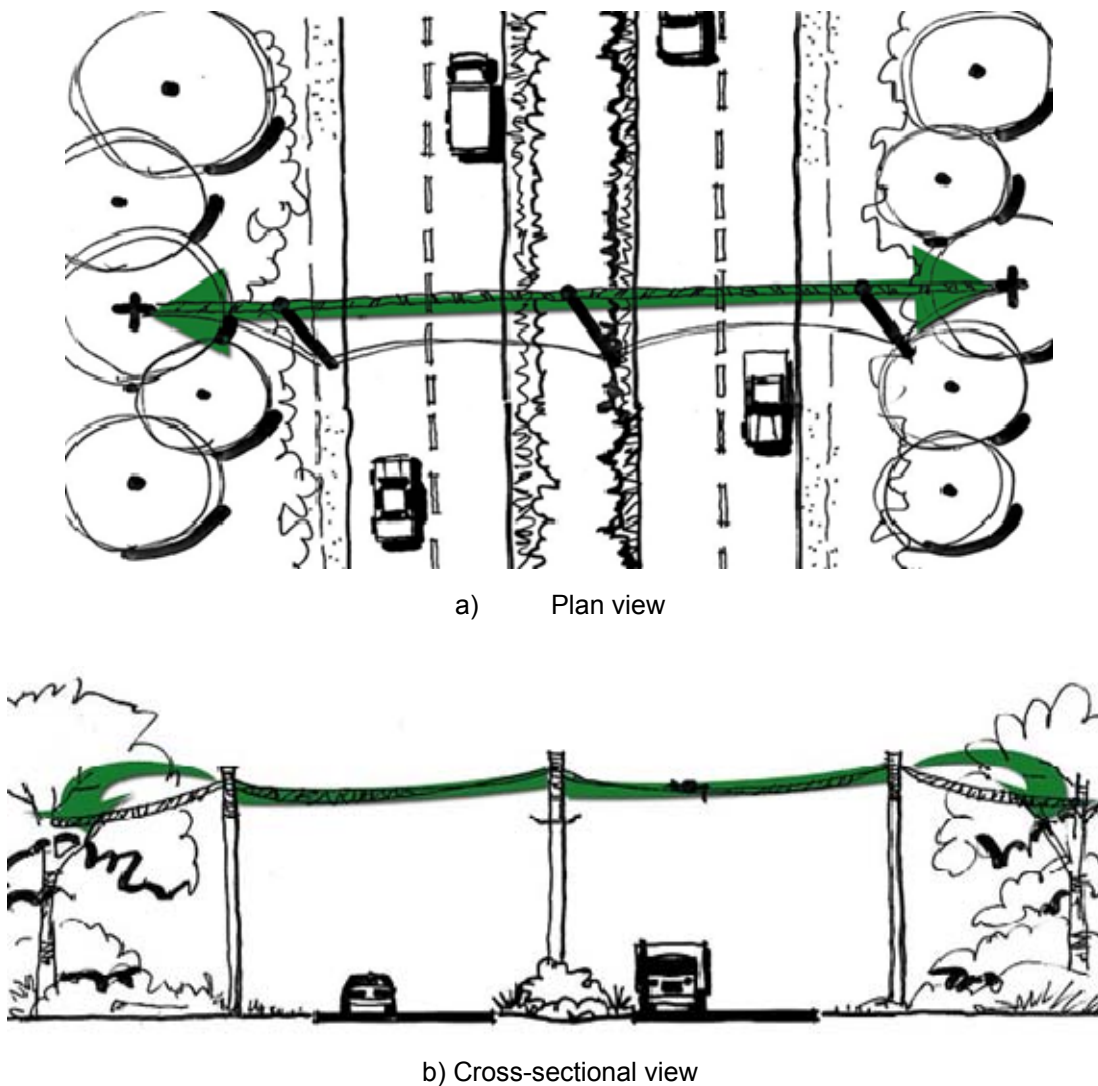

Figure 6.4.2 Diagrammatic representation of a canopy bridge designed to accommodate arboreal species.

6.4.1 Target species

Refer to Section 7.4: Arboreal Species for additional species information.

6.4.2 Design specifications

- There are no standards regarding optimal dimensions of rope tunnels or ladders. Investigations during the design phase are required to determine the size of the largest animal most likely to use the structure.
- Supports are usually constructed from recycled electricity poles.
- Minimum of seven metres clearance from the road (to allow for traffic to pass underneath as well as sufficient height above traffic noise). Some have been constructed 12 metres above the road.
- Connected to adjacent vegetation via ropes (Figure 6.4.3).
- Provide crossing opportunities for possums every 100 – 120 metres when possum home ranges coincide with the road corridor.
- A cost-benefit analysis is required in areas with a high number of tree-kangaroos, before the installation of rope structures and/or culverts.

- Consider potential conflict with adjacent powerlines and other service infrastructure.
- Comply with safety requirements when structural supports are placed in the road median or road-edge. These may need safety barrier or guardrail protection.
- Consider roadway clear zone requirements and design of roadside hazards (refer Chapter 8 of TMR Road Planning and Design Manual 2005).
- More research is required to determine the effectiveness of scenting the rope with urine to attract use by target arboreal species.
- Construction technique previously utilised:
 - Screw eyelets into the pole and attach rope and attach 12-14 gauge marine grade silver (high UV rating) rope and stainless steel cables and frames (for rope tunnel).
 - Attach sheet metal above the rope bridge connection points to prevent arboreal species from ascending further.
 - Attach sheet metal or metal cones to support poles in the middle of the roadway to ensure animals are unable to descend in the median between traffic lanes, and to hinder predators from using the structures.
 - Appropriately tension canopy bridge.



Figure 6.4.3 Canopy bridge at Compton Road, Brisbane. Bridge is connected to the surrounding environment by ropes (Robinson-Wolrath 2007).

a) Rope tunnel

- Refer to Figures 6.4.4 and 6.4.5.
- Dimensions are: 200 mm high x 300 mm wide.

- Design ensures stability when two or more individuals are crossing simultaneously or in strong winds.
- Design allows fauna to avoid predators or another individual crossing simultaneously.
- Design considerations:
 - Ensure entrances and exits are rectangular.
 - Connected to poles via steel cables.
 - A stainless steel frame can increase strength of tunnel.
 - Vegetation growth on tunnel may promote use, particularly when vegetation is a food source.
 - Case study: A rope tunnel in New South Wales has been constructed which is covered in shade cloth to reduce headlight glare. No monitoring of this structure has been undertaken to determine effectiveness.
- Species-specific information:
 - Research has shown that green, Herbert River and lemuroid ringtail possums utilise rope tunnels.
 - Rainforest ringtail possums have been observed crossing a rope tunnel which is 45-50 metres long.
 - Brushtail possums and squirrel gliders have been observed utilising a rope tunnel that is 70 metres long.
 - Some species (particular possums and rodents) prefer to travel on top rather than through the tunnel.



Figure 6.4.4 Rope tunnel crossing, northern New South Wales (Robinson-Wolrath 2007).

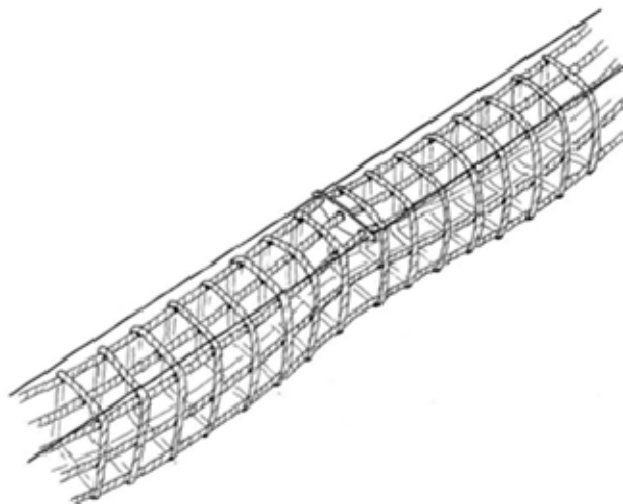

Figure 6.4.5 Rope tunnel

b) Rope ladder

- Refer to Figure 6.4.6.
- Preferred canopy bridge structure.
- Constructed to resemble a ladder.
- Adapted from tunnel design because research found possums only crossed on top of the traditional box canopy bridge structure.
- Attracts more species than other types of canopy bridge structure.
- Design considerations:
 - Research indicates there is no correlation between the rope ladder's use and its length (Weston 2003).
 - Ensure stability even when two or more animals are crossing simultaneously or in strong winds.
- Species-specific information:
 - Ringtail possums predominantly utilise these structures.
 - Case study: A rope bridge constructed where no connectivity existed before was utilised within five months by ringtail and brushtail possums (Weston 2002).

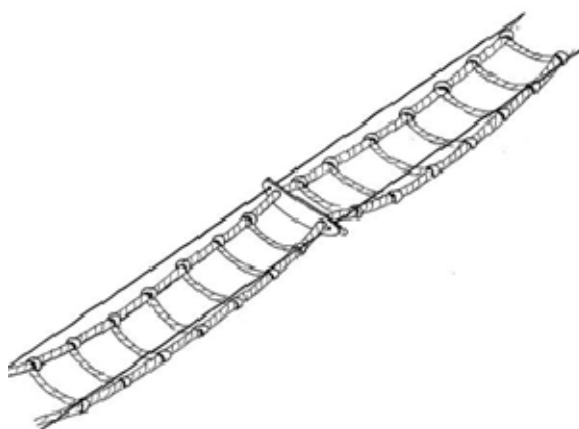

Figure 6.4.6 Rope ladder.

c) **Single rope crossings**

- Refer to Figure 6.4.7.
- Excludes use by several fauna species.
- Requires regular maintenance as it is affected by turbulence and is susceptible to losing tautness which reduces overhead height.
- Species specific information:
 - Ringtail possums have been known to cross single wires 8 mm wide and 50 metres long (Magnus *et al.* 2004).



Figure 6.4.7 Single rope crossing structure.

Advantages for canopy bridge structures:

- Economical.
- Allow species that never descend to the ground to migrate and disperse.
- Used by a variety of species.
- Possess tourist appeal which increases awareness of wildlife.

Disadvantages for canopy bridge structures:

- No standard design principles established.
- Single rope crossings are not utilised by the majority of fauna due to stability, turbulence and weight issues.
- Single rope crossings are susceptible to loss of tautness which reduces overhead height clearance.

Maintenance requirements for canopy bridge structures:

- Ensure ropes do not deteriorate or decay.
- Inspect on an annual basis or after storm events (or similar events causing tree falls).
- Ensure that heavy vegetation does not grow on bridge as it can place stress on the bridge, increase decay rate and cause false triggering of monitoring cameras.
- Single rope crossings require regular maintenance as they are affected by turbulence.
- Single rope crossings require more frequent inspections and maintenance.

6.5 Overpass: Poles

Vertical poles placed in the centre median, on the road verge or on overpasses to provide species with intermediate landing points and/or multiple launch opportunities (Figures 6.5.1 and 6.5.2). Alternatively, poles can also aid species to disperse in open areas by providing refuge from predators.

6.5.1 Target species

- Glider Poles:
 - Species which have the ability to glide between vegetation.
 - Refer to Section 7.4: Arboreal species.
- Refuge Poles:
 - Koalas.
 - Tree-kangaroo species.
 - Refer to Section 7.5: Koalas and Section 7.8: Macropods.

6.5.2 Design specifications

a) Glider poles

- Primary use is to provide a launching pad for gliders.
- May be a temporary measure while awaiting canopy connectivity.
- Locational considerations:
 - Fauna movement pathways.
 - Natural tree growth and future canopy connectivity (poles will not be utilised if a canopy crossing is available).
 - Use by juveniles (may have shorter glide distances).
 - Topography.

Design requirements:

- Gliders prefer to glide between trees but if a pole is closer they may utilise the pole.
- Can be constructed from used electricity poles or tree trunks salvaged from the site.
- Consider potential conflict with adjacent powerlines and other service infrastructure.
- Consider height of poles, height of crossbars and distance between poles. Use trigonometry to determine the specific requirements.
- Minimum height of 12 metres. Additionally, must be of sufficient height to allow gliders to pass over trucks.
- Cross bars should be provided at various heights. Highest crossbar at least 11 m above the ground.
- Distance between poles:
 - Allow for an average of 1.8 metres flying distance with a one metre loss in elevation.
 - Research on sugar, mahogany and squirrel gliders shows an average glide angle is 30.5° with a one metre loss in height for every 1-2 metres in glide length.
- Attach metal around poles (below launch points and any refuges) to stop gliders from descending to the ground.
- Predation refuges can be added. Presently the design for such refuges consists of: three PVC pipes (110 x 380 mm) attached to each pole at heights of approximately 9, 10 and 11 metres.

- Structural supports placed in the road median or road-edge may require safety barriers or guardrail protection to comply with safety requirements.
- Roadway clear zone requirements and design of roadside hazards need consideration (refer Chapter 8 of TMR Road Planning and Design Manual 2005).
- For additional species-specific information see Table 6.5.1.
- Case study: glider poles in the Miriam Vale region were not used at all by gliders as they preferred to utilise remaining trees (Wormington 2006).
- Case Study: squirrel gliders adapted easily to utilising glider poles at Compton Road, Brisbane. They were frequently recorded on glider poles within a year at sites where they had not previously occurred.
- Case study: research regarding the requirement for vegetation at the base of glider poles is inconclusive. It has been suggested that glider poles without vegetation around the base will remain unused (van der Ree *et al.* 2007). However, other research indicates gliders will use the glider poles if they can sense food on the opposite side of the road.

Table 6.5.1 Specific recommendations regarding glider poles

Species	Average glide lengths	Minimum crossbeam (launch) height	Spacing between structures	Height of structure
sugar glider (Petaurus breviceps)	48 m with a launch height of 25 m ¹ .	11.96 m (average) ¹ .	Maximum distance 60 m ³ .	Dependent upon length required to glide (ie distance between structures). Use trigonometry to determine.
squirrel glider (Petaurus norfolcensis)	80 m with a launch height of 45 m ¹ . Average glide of 30-40 m ² . Average glide length is one metre with one metre decrease in height.	11.96 m (average) ¹ .	Maximum distance 60 m ³ .	
yellow-bellied glider (Petaurus australis)	Maximum 30 m glide ⁴ .	11.96 m (average) ¹ .	No more than 30 m.	
mahogany glider (Petaurus gracilis)	Glide length unknown.	11.96 m (average) ¹ .		
greater glider (Petauroides volans)	25–35 m with a launch height of 20–25 m ¹ .	11.96 m (average) ¹ .	Maximum distance 60 m ³ .	
feathertail glider (Acrobates pygmaeus)	Maximum glide of 20–30 m ¹ .	11.96 m (average) ¹ .	No more than 30 m.	
General	Most species can glide 1.8m with a one metre loss in altitude ¹ . Average glide angle is 30.5 degrees.		All Australian gliders (except feathertail and yellow-bellied gliders with a maximum glide of 20–30m ¹) can glide at least 60m ³ .	

¹Australian Museum Business Services 2001

² van der Ree 2006

³ Weston

⁴ Strahan 1995

Advantages

- Cost-effective technique for ensuring connectivity.
- Acts as stepping stones for crossing traditionally unfavourable habitat.
- Provides refuge from predators.
- Utilised by a variety of fauna.
- Encourages community and tourist awareness.

Disadvantages

- Rate of use dependent upon species present.
- May remain unused if not positioned correctly.
- No standard design principles have been established.

Maintenance Requirements:

- Ensure glider poles and crossbeams are not decayed.
- Tree trunks require more frequent replacement than reused electricity poles.



a) Cross-sectional view

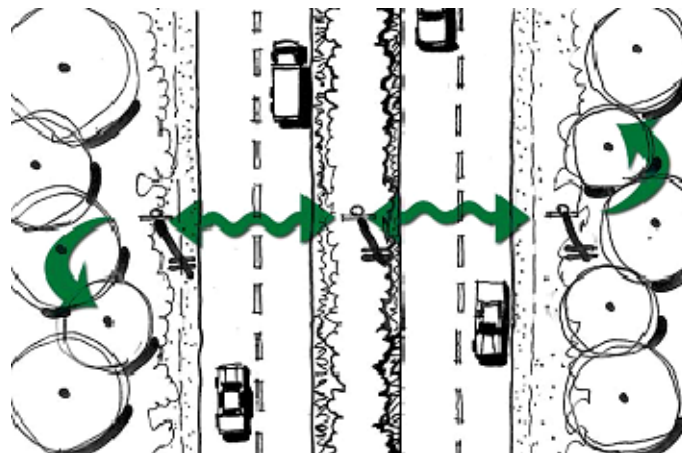

b) Plan view

Figure 6.5.1 Indication of glider movement utilising glider poles to cross a road.

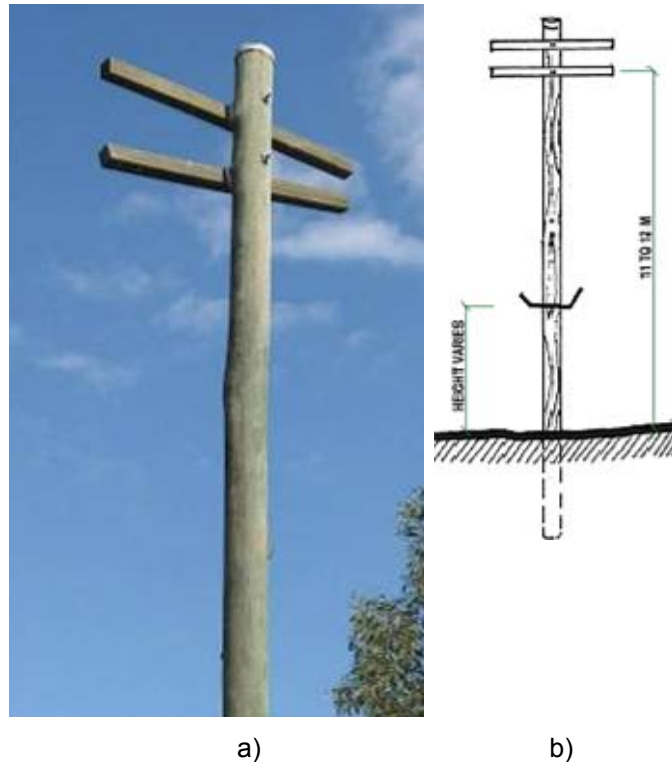

Figure 6.5.2 a) Glider pole at Compton Road, Brisbane (Robinson-Wolrath 2007). b) Glider pole.

b) Refuge poles

- Primarily used for predation refuge for tree-kangaroos and koalas.
- May be used in conjunction with vegetative corridors or utilised as a temporary measure while awaiting revegetation works to mature.

Tree-kangaroos

- At least five metres in height.
- Constructed out of old electricity poles with four treated pine pieces of wood (100 x 50 mm rafters) bolted together to form a pyramid shape (Figure 6.5.3).
- Most efficient and effective when installed in rows across open areas and along known tree-kangaroo dispersal routes.
- Case study: tree-kangaroo refuge poles have been installed as part of the Anderson Road Landscape Linkage Package. Four poles were installed at 30-40 metres intervals for use by Lumholtz tree-kangaroos (Figures 6.5.3 and 6.5.4).
 - Constructed of old electricity poles.
 - Cross bars were bolted to poles five metres above ground level for tree-kangaroos to rest on.
 - Covered with shade cloth to provide shelter for animals that may become stranded during the day.
 - Main pole is 300-400 mm in diameter. This is considered to be the upper end of stem size climbed by the target species.
 - The lower part was roughened and a thick rope was installed to aid climbing.
- There are currently no reports indicating effectiveness of these structures.

Advantages

- Structures are a cost effective way of maintaining habitat connectivity.

Disadvantages

- Short life span (5-10 years).

Maintenance Requirements:

- Low maintenance.
- Shade cloth may require replacement after storm or strong wind events.



a)

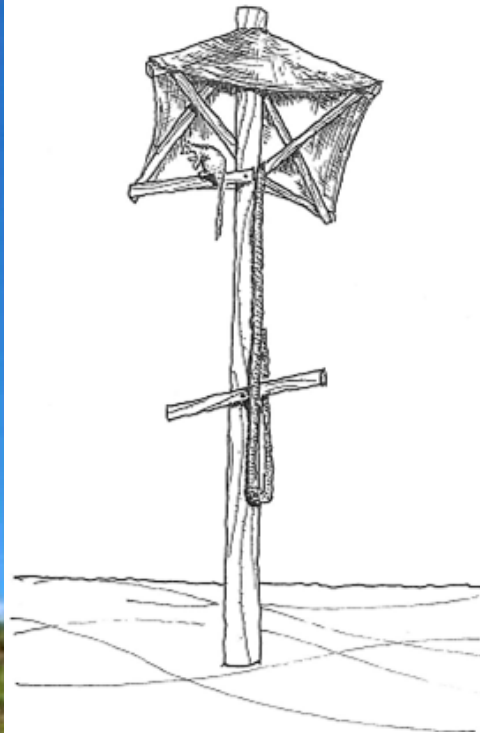

b)

Figure 6.5.3 a) Tree-kangaroo refuge pole (Tree-Kangaroo and Mammal Group 2008).
b) Tree-kangaroo using a refuge pole.



Figure 6.5.4 Refuge poles installed as part of the Anderson Road Landscape Linkage Package (Tree-Kangaroo and Mammal Group 2008).

Koalas

- Escape poles installed on the roadside of fencing to provide koalas with a refuge if unable to escape the road corridor.
- Utilised at the entrance and exit points to fauna culverts to provide resting and predator avoidance points.
- 200 mm diameter is optimum but no more than 500 mm in diameter.
- Sufficient height (between three and six metres) to provide refuge from predators such as dogs.
- Timber or rubberized cement.
- Installed at least every 200 metres along the road.
- Installed against fauna exclusion fencing may provide a means for koalas to return to vegetative side unassisted (Figure 6.5.5).
 - Metal sheeting must be installed to prevent koalas from using poles to gain access to road corridors.
 - Research into the effectiveness of this design is required as metal sheeting requires koalas to jump down from poles.
- Can be installed in place of suitable vegetation on land bridges, in front of and throughout underpasses and anywhere else they are required.
- Install on the basis of expert advice.

Advantages:

- Allows safe escape from road.
- Provides refuge from predators.
- Inexpensive.
- Does not affect efficacy of fence.
- Can be used by a variety of fauna species.

Disadvantages:

- In most circumstances, requires person to remove the koala to habitat side of fence (Figure 6.5.6).
- May remain unused if incorrectly positioned.

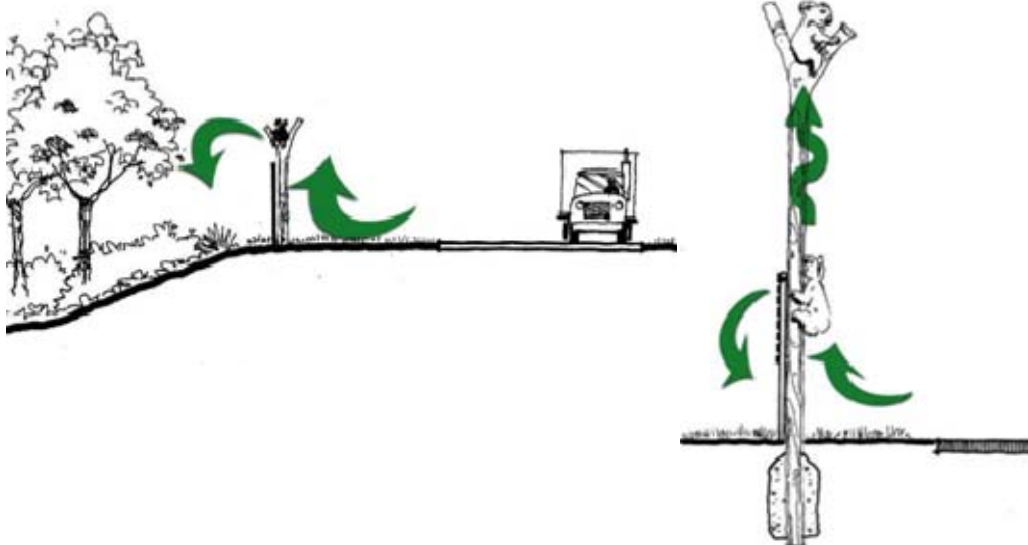

Figure 6.5.5 Escape pole design aimed at assisting koalas to escape the road corridor and return to vegetative side unassisted.



Figure 6.5.6 *Escape pole at Compton Road, Brisbane. Note: Koalas must be assisted to return to vegetative side of fence.*

6.6 Underpass: Culvert

Culverts are square, rectangular or half circle in shape and may be purpose built for fauna (terrestrial and/or aquatic) passage or water drainage, or a combination of both. They are typically pre-cast concrete cells or steel arches.

Factors affecting the success of a fauna culvert:

- Substrate, may be species-specific (for example, concrete, mulch, bare earth).
- Presence of hiding places or escape routes.
- Presence of suitable vegetation cover, native plant species, rocks and logs at entrances, exits and throughout.
- Length (should be minimised, but dependent on openness).
- Drainage requirements.
- New technology and methods.
- Monitoring.

6.6.1 Target Species

- Most aquatic and terrestrial species.

6.6.2 Design Specifications

- Consider the safety of all road users.
- For the design and location of the ends of the structures (ie wing walls) check clear zone and road side hazard requirements.

Design determined by:

- Target species (aquatic or terrestrial species):
 - Specific groups of fauna.

- Behaviour of fauna.
- Environment:
 - Hydraulic requirements.
 - Soils.
- Dimensions (dependent on size of road itself).
- Cost of construction.
- Cost of maintenance.
- Monitoring requirements.

a) Design of structures for aquatic species

- Design in close consultation with an appropriate expert or the Queensland Primary Industries and Fisheries.
- Consider specific fish passage requirements when selecting culvert type.
- Arch, pipe or box-shaped cells allow water to pass underneath the roadway.
- Usually made of concrete or galvanised corrugated steel pipe.
- Types of culverts (Table 6.6.1 in descending order of preference):
 - Arch culvert.
 - Open-bottom box culvert.
 - Stream simulation design with buried base box culvert.
 - Multicell culverts.
 - Closed-bottom box culvert.
 - Pipe culvert.
- Design and/or maintain appropriately to ensure effective fish population connectivity.
- Perched culverts are not appropriate. Larger bottomless and buried base box culverts are preferred for fish passage.
- Ensure erosion and scour management is adequate.
- Usually made of concrete or galvanised corrugated steel pipe.
- Stream simulation design recommends:
 - Burying the base of the culvert and reconstructing the stream bed within the cell.
 - Cell width to be as wide as the bank full waterway width.
 - Cell area to be as large as the bank full waterway area.
 - Install multicell culverts at the same level as the waterway bed profile. The low flow cell must provide for fish passage at low flows with the outer cells providing for fish passage at mid and flood flow levels.
 - Install the base of the culvert cell at the waterway gradient.
- Sediment control debris deflector walls can be used to reduce the impact of debris blockages on fish passage while also reducing maintenance costs. Debris deflector walls decrease flow velocities at the entrance to culverts causing suspended materials to fall outside the culvert rather than accumulate in baffle structures (Figure 6.6.1).
- Optimal culvert placement allows for fish movement in high and low water flows (Figure 6.6.2).
- For information on the general effectiveness of structures refer to Table 6.6.2.

Advantages

- Must be designed and maintained correctly to maintain fish passage.

Disadvantages

- If not designed and maintained appropriately will be ineffective (for example, Figure 6.6.3).
- Head cut erosion, if present, creates fish passage issues.
- Elevated culvert crossings (above the stream bed) create a drop on the downstream side causing a physical barrier to fish (100 mm is a barrier to most native fish) (Cotterell 1998).
- If culverts are too long they form physical and behavioural barriers to fish. Some fish hesitate at the entrance to long dark culverts and refuse to travel through them.

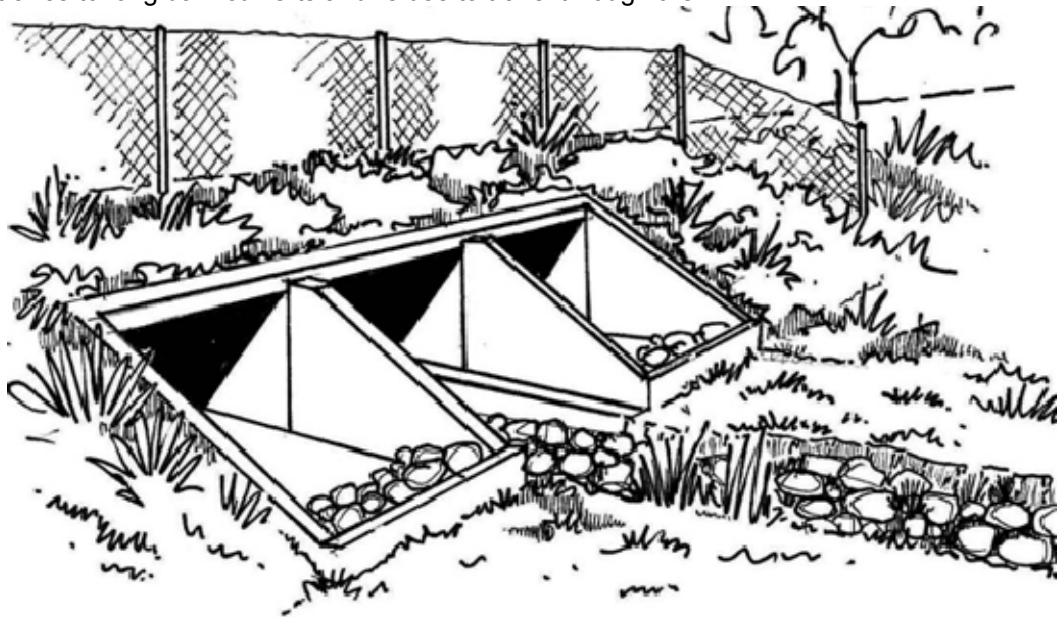

a) Perspective view

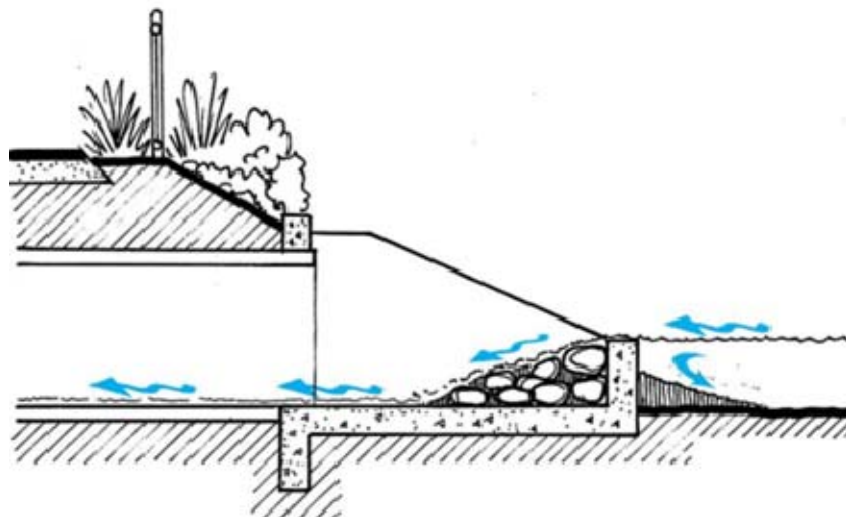

b) Cross-section

Figure 6.6.1 Debris deflector walls decrease flow velocities at the entrance to culverts causing suspended particles to fall outside the culvert rather than accumulate in baffle structures (Fairfull and Witheridge 2002).

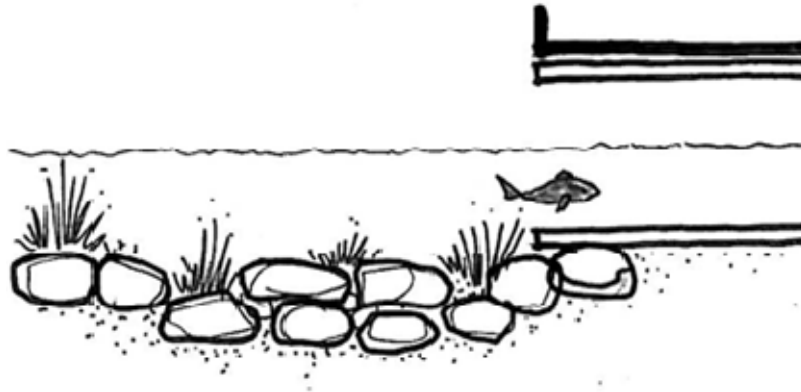

a) Fish passage maintained during high flow

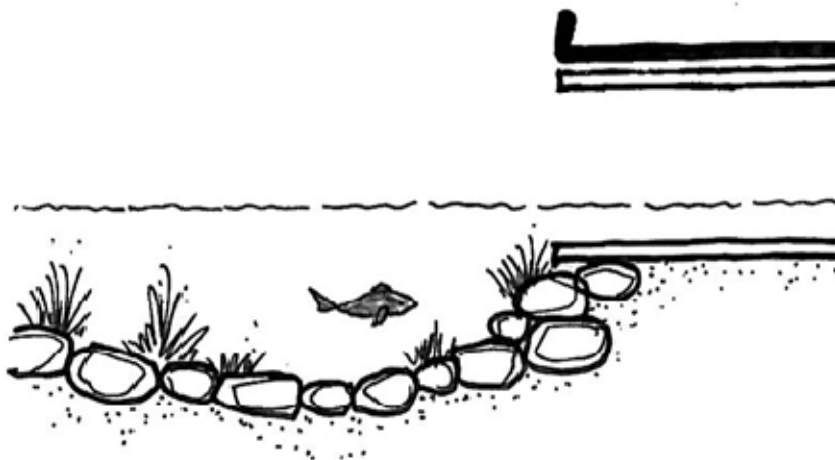

b) Fish passage maintained during low flow

Figure 6.6.2 Optimal culvert position allows for fish movement in high and low water flows.

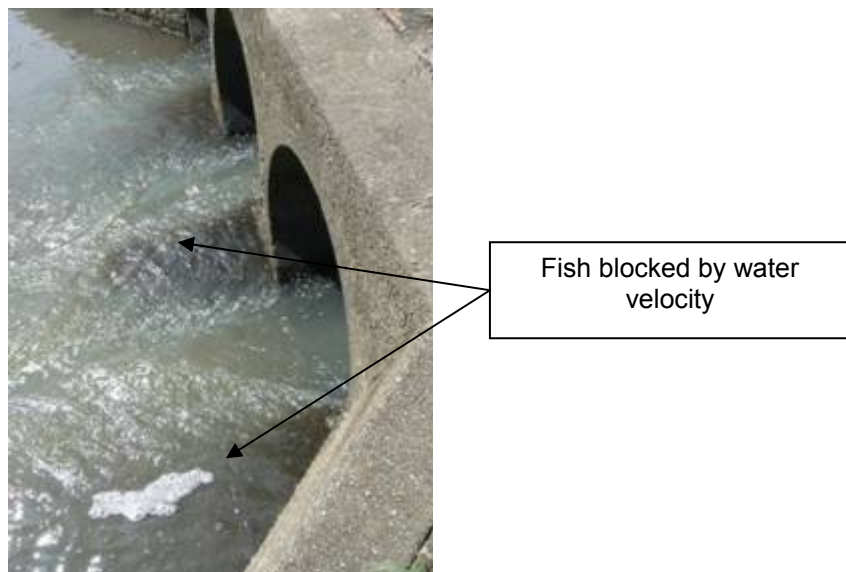
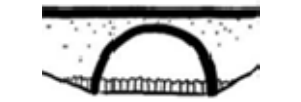





Figure 6.6.3 Water velocities blocking fish passage (Yates 2010).

Table 6.6.1 Types of culverts for aquatic species (in order of descending preference).

Type		Details	Advantages	Disadvantages
Arch culvert		<ul style="list-style-type: none"> Arch culverts should be no more than six metres in length and have a minimum three metre width, when light maximisation is proposed. 	<ul style="list-style-type: none"> Retains the natural stream bed profile and original flow of water. 	<ul style="list-style-type: none"> The advantages of using arch culverts (for example, increased light and free water flow) may be lost if they are not wide enough (minimum width three metres) The installation of arch culverts involves excavation for the culvert footings which can cause substantial disturbance to natural stream beds and banks.
Open-bottom box culvert		<ul style="list-style-type: none"> Retains the natural streambed with a box-shape culvert overhead. 	<ul style="list-style-type: none"> Retains the natural stream bed profile and original flow of water. If large enough, flow will not be constricted and debris will not be trapped during normal flow conditions. 	<ul style="list-style-type: none"> If poorly designed, installed or maintained it can be a barrier to fish passage in all flow conditions.
Multicelled culvert		<ul style="list-style-type: none"> If multiple culverts are needed to span the stream bed, one or more should be slightly lower than the others to concentrate low flows and allow fish to swim through. 	<ul style="list-style-type: none"> May ensure there is flow during low flow periods. 	<ul style="list-style-type: none"> One large culvert spanning the width of the waterway is preferable to two or more small culverts because it is usually more efficient hydraulically. If poorly designed, installed or maintained it can be a barrier to fish passage in all flow conditions.
Closed-bottom box culvert		<ul style="list-style-type: none"> Entirety of crossing is box-shaped concrete structure, retaining no natural stream bed. Important to consider flow velocities within culvert. 	<ul style="list-style-type: none"> May be simpler to construct if stream is redirected throughout construction. 	<ul style="list-style-type: none"> If poorly designed, installed or maintained it can be a barrier to fish passage in all flow conditions. If poorly designed erosion may cause drop downs at the end of the culvert.

Type		Details	Advantages	Disadvantages
Pipe culvert		<ul style="list-style-type: none"> • Entirety of crossing is pipe-shaped concrete structure, retaining no natural stream bed. • Important to consider flow velocities within culvert. 	<ul style="list-style-type: none"> • May be simpler to construct if stream is redirected throughout construction. 	<ul style="list-style-type: none"> • If poorly designed, installed or maintained it can be a barrier to fish passage in all flow conditions. • If poorly designed erosion may cause drop downs at the end of the culvert.

Table 6.6.2 Factors that determine the effectiveness of culverts for aquatic species movement

Considerations	Description	Mitigation
Flow velocity	<ul style="list-style-type: none"> Function of slope, roughness, culvert size and length. To control velocity, all these parameters should be considered in the passage design. In natural streams, channel irregularities, pools, meanders and other similar features provide zones of slow water where fish can rest. These areas do not exist in culverts where the velocities are uniform throughout and are usually greater than those in natural channels. Velocity should not exceed pre-development conditions (determine target fish species' requirements). 	<ul style="list-style-type: none"> Include baffles and/or rocks sized at 25% culvert width, spaced the same distance apart, or using the natural stream bed. Install a larger size culvert than that required for hydraulic flow. Use a greater number of culverts (multiple culverts). Increase the depth of the culvert below the stream bed. Design so the weakest fish can swim through the structure.
Flow depth	<ul style="list-style-type: none"> Important there is sufficient water inside the culvert to allow the fish to pass through. The depth depends on the cross-sectional shape. Box culverts disperse flow to a greater extent than pipe culverts which concentrate water during low flow. Curtain aprons reduce water depth. 	<ul style="list-style-type: none"> Flow depth should be a minimum of 200-500 mm to encourage fish passage. Design to ensure the largest fish remain submerged.
Turbulence	<ul style="list-style-type: none"> Increasing the internal surface roughness of culverts increases water turbulence within the culvert. Turbulence can also be an issue at the culvert inlet. Culvert alignment and headwall shape influence water turbulence. 	<ul style="list-style-type: none"> Decrease surface roughness (Note: this will affect water velocity. The balance between increasing surface roughness to decrease flow velocity and decreasing surface roughness to decrease turbulence is unknown). Culvert cells should be aligned with the waterway ensuring turbulence does not increase through the cell. Natural waterway bed of bottomless and buried culverts best provides for fish passage. In higher velocity locations the headwall may need to be rounded to reduce turbulence.
Debris blockage	<ul style="list-style-type: none"> Debris itself will not create a barrier, but when combined with other difficulties, such as increased water velocity and/or culvert length, the total effort required may exceed the swimming ability of the fish. Trapped debris may also cause injury to fish. Debris can impair a fish's swimming ability and in turn affect their spawning 	<ul style="list-style-type: none"> Wide, short box culverts are the most desirable to ensure minimum debris accumulation. Avoid debris blockage by conducting routine maintenance checks. At sites with high debris loads, debris deflector walls may be required to avoid blockage. Wider culvert cells have fewer

Considerations	Description	Mitigation
	success and increase mortality.	debris issues.
Sediment control	<ul style="list-style-type: none"> Sedimentation can reduce the culvert's hydraulic capacity, increase upstream flood levels, fill habitat and fish resting pools, and cause the permanent flooding of terrestrial pathways (dry cells). 	<ul style="list-style-type: none"> Vary the invert level of culverts to simulate the channel's natural cross section, but this may not allow sufficient flood capacity. Alternatively, construct sediment training walls in front of the 'dry' cells (Figure 6.6.1). Larger culvert cells (bottomless or adequately buried) allow sediment transport to remain at equilibrium. Additional measures must be taken to prevent undercut and head cut erosion from occurring.
Length	<ul style="list-style-type: none"> Excessive length, when coupled with excessive water velocity or turbulence, can create a barrier to fish passage. The majority of fish are unable to maintain burst speeds long enough to swim the entire length of most culverts. If the distance is too great (greater than six metres), fish may tire before reaching the other end and be swept back downstream (dependent upon target species). Long culverts can be dark, which may discourage some fish species. 	<ul style="list-style-type: none"> Construct perpendicular to the flow to minimise the length needed (less than four metres) and allow fish to swim through, where possible. Ideally, culverts should be less than six metres, if no resting areas are available and/or water velocity is faster than pre-development conditions. Longer culverts may be considered if other requirements for effective fish passage are met (for example, lower water velocity, greater width and illumination).
Width	<ul style="list-style-type: none"> If culverts are not as wide as the natural stream bed, water flow is restricted and water velocity increased. Narrow culverts are dark and tend to accumulate debris, which may result in blockage. 	<ul style="list-style-type: none"> Large diameter culverts provide easy access and are easy to maintain. Should be at least 600 mm wide, but the overall crossing structure should be as close as possible to the natural stream width to ensure minimum flow restriction.
Lighting	<ul style="list-style-type: none"> Long dark, or intermittent light patches (gaps or skylights) can be a barrier to fish passage. 	<ul style="list-style-type: none"> Maximise available natural light by making the dimensions of the culvert as large as possible. Skylights set in the bridge decking are only justified when endangered fish species are present that are sensitive to total darkness.
Water level across inlet and outlet	<ul style="list-style-type: none"> For culverts which are not at stream level the jump or drop may be impassable for most fish. 	<ul style="list-style-type: none"> In situations where erosion is a likely issue in the future, arch structures are preferable. Countersinking of culverts below the stream bed is strongly recommended. Design culverts with a specified minimum countersunk dimension (a

Considerations	Description	Mitigation
		minimum of 20% of the culvert diameter).
Culvert slope or gradient	<ul style="list-style-type: none"> If culverts are placed on a significant slope, most fish will be unable to negotiate them. 	<ul style="list-style-type: none"> Crossings should be placed in parts of the stream where slope is minimal. Avoid using culverts on a waterway that has a gradient of more than two percent (1:50). The gradient immediately downstream of the culvert should be less than five percent (1:20) so fish can approach the culvert outlet. The culvert gradient should be similar to that of the stream, which should be gently sloping. For multicelled culverts follow the natural waterway bed profile.

Multicell culverts

- A multicell culvert spanning the entire stream is more beneficial to migrating fish than a single culvert that does not span the stream width.
- Allows water velocity to remain similar to the natural stream condition.
- Box and pipe culverts can be utilised into multicell culvert designs.
- Pipe culverts can be used mid-stream to move the bulk of the water, with box culverts installed at the stream edges where water flow velocities allow fish passage.
- When installing multicell culverts, they should be staggered at different heights, with the lowest in the middle of the stream channel, concentrating the water during low flow.
- Install at the waterway bed profile.

Baffles

- Refer to Figures 6.6.4 and 6.6.5.
- Before installing seek expert advice to ensure correct placement.
- Appropriate for new culverts and retrofit for existing culverts, but should only be used when stream simulation designs cannot be implemented.
- Act as energy dissipators.
- Increase roughness of the surface of the culvert to reduce water velocity.
- Change the flow pattern in the immediate vicinity, creating a sequence of slow and fast water zones. This allows fish to use burst speed to advance from one resting place to the next and cruising speed to swim through the resting zones.
- For multiple parallel culverts, only those near the stream banks should be fitted with baffles.
- Types of baffles include: offset baffle, spoiler baffle, side/corner baffle, angle baffle, notch baffle, weir baffle (Kapitzke 2009).

Disadvantages

- Likely to snag debris and therefore, require additional maintenance.



a)

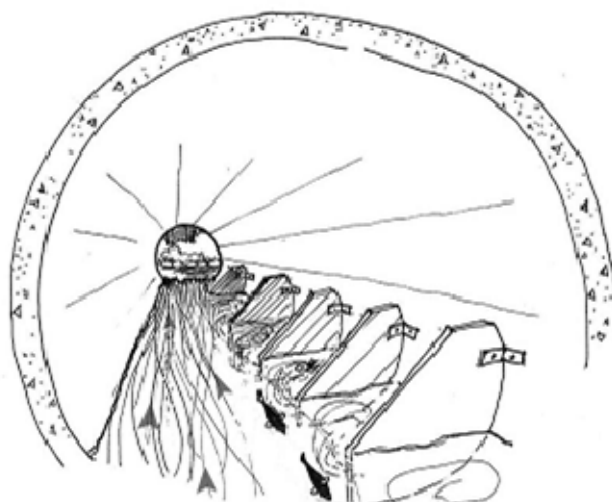

b)

Figure 6.6.4 Cross sectional view of baffle designs.
a) Baffle design for a box culvert
b) Baffle design for a pipe culvert (Kapitzke 2009).

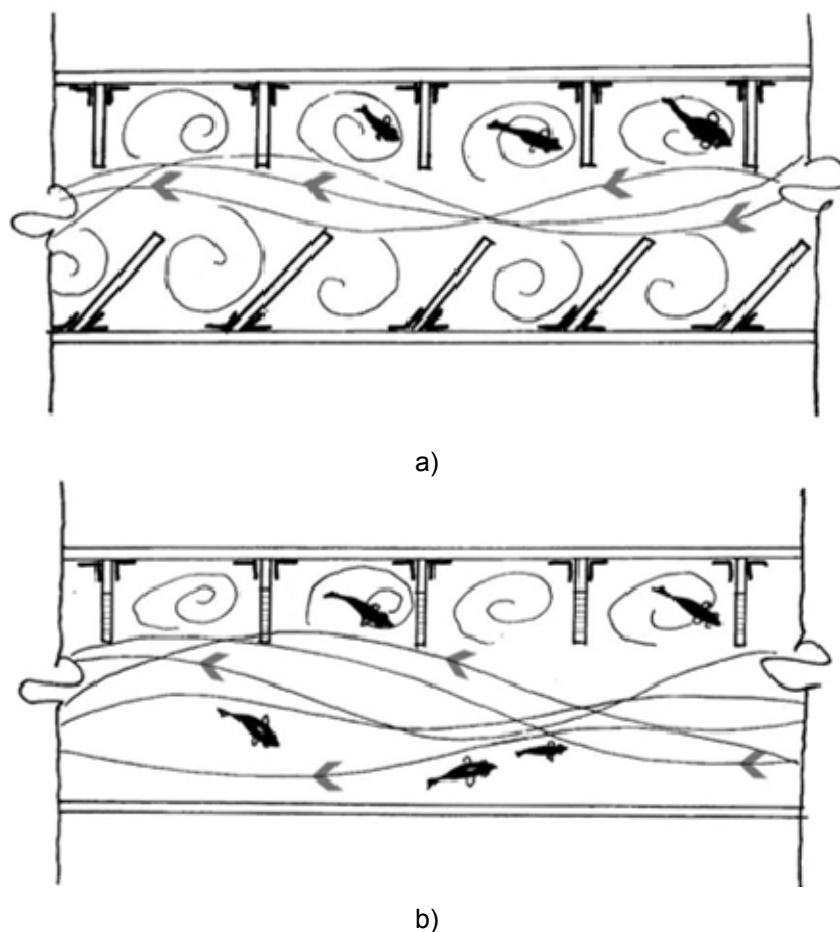

Figure 6.6.5 a) Culvert section with baffles installed on both sides of the culvert
b) Culvert section with baffles installed on one side of culvert. This allows high velocity water flows on one side and provides rest areas for fish species (Kapitzke 2009).

Culvert rehabilitation

- Existing culverts can be rehabilitated to improve fish passage conditions. This can be done by:
 - Inclusion of baffles to the bed of wet cells.
 - Downstream channel modifications to raise low-flow water levels within the culvert.
 - The addition of sidewall roughness.
 - Upstream channel modifications to remove drop inlets or excessively steep rock ramps.
- Fishways may be installed to address existing fish movement barriers and outlet erosion drop issues.

Rock ramps

- Are constructed by placing large rocks placed within the stream to form a staircase-type arrangement. This slows flows and forms resting locations for fish at the exit of culverts or leading up to weirs (Figure 6.6.6).
- Accommodates up- and down-stream migration.
- Allows migration even during low flow.
- Are used by a variety of fish, in particular smaller fish.
- Cater for a variety of fish behaviour and movement patterns.
- Gradient and design are determined by maximum swimming speeds of various fish.
- Full width rock ramps are optimal but partial rock ramps are most common.

- Design correctly to ensure appropriate hydraulic conditions.
- Can incorporate traverse or randomly placed ridge rocks to mimic flow conditions (Kapitzke 2009).

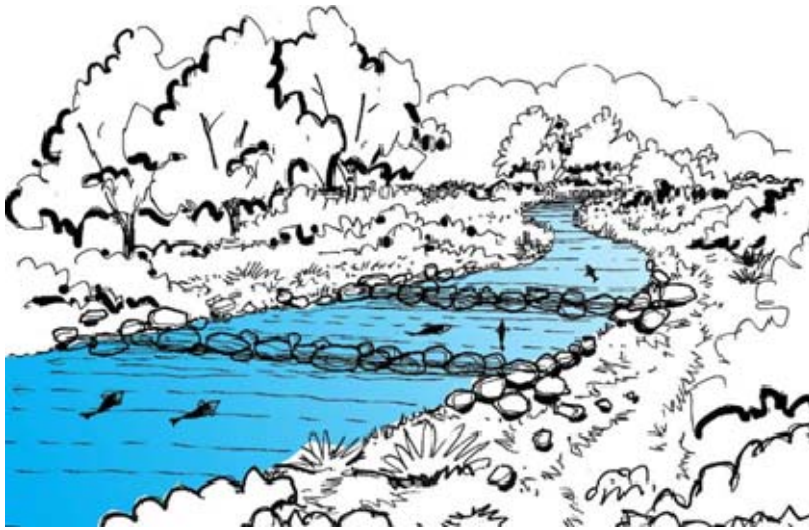

a) Perspective view

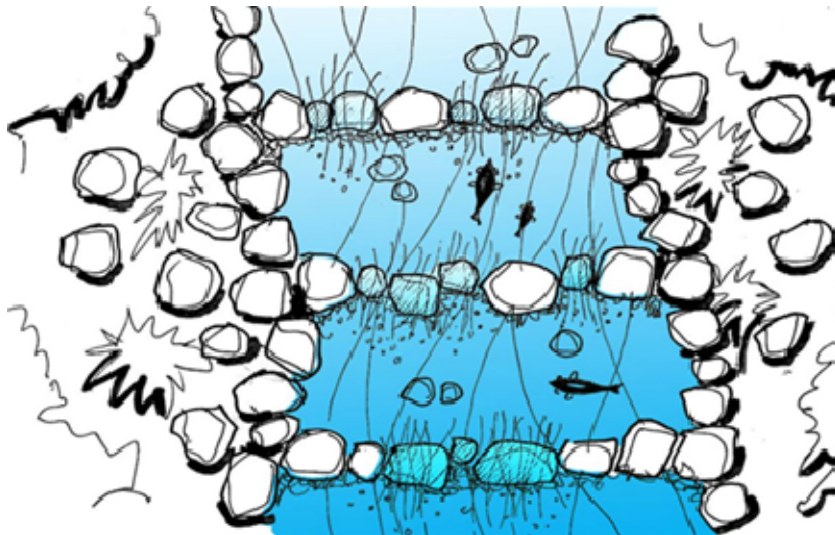

b) Perspective view



c) Cross-sectional view

Figure 6.6.6 Rock ramps allow fish migration during a variety of flow periods.

Fords

Fords are vehicle crossings that are approximately level with the river bed. Low flows pass over the structure rather than through a culvert. If the bed level is raised by the use of concrete or rocks, the crossing then becomes a causeway.

- Used when infrequent vehicle use is anticipated (if more frequent use is anticipated, a permanent or temporary culvert may be needed to prevent disturbance to the channel).
- Fords are 'wet' crossings so they should be used only when flows are low or non-existent.
- Fords are suitable for intermittent waterways with little or no defined drainage channel, no lasting pools and little or no vegetation.

Design requirements:

- Site to have a stable, non-erodible rock or bedrock base to minimise siltation from traffic.
- Sandy, vegetated and silty sites are not appropriate.
- Install perpendicular to the waterway.
- Concrete fords should have a 'V'-shaped or rounded notch on the lowest point of main channel so fish can swim across the ford during times of low flow. The 'V' or notch should be at least 50 mm deep and 300 mm wide.
- Avoid deep box cuts on the approaches to the ford. The height of the banks adjacent to the ford should be less than two metres.
- If rocks are used they should be almost level with the stream bed and not affect flows significantly.
- Only clean material from another site should be used. Excavating rock from the stream is rarely acceptable.
- Ensure the surface of the ford is erosion-proof, for example interlocking angular rock or concrete.
- Should not be made of smooth concrete.
- Design access tracks to ensure sediments and pollution do not enter the waterway.

Advantages

- If designed in accordance with environmental requirements there may be a cost-effective compromise between vehicle movement and fish passage.

Disadvantages

- A fence may be needed to stop livestock entering the stream from the ford.
- Poorly designed and sited fords may trigger stream bed and bank erosion.
- Frequent use of unhardened fords may destabilise the channel.
- A vertical drop created due to erosion will prevent or create difficulties for fish and other aquatic animals to travel upstream across the ford.
- Flows are often spread across the width of fords during low flows. As a result, the water may be too shallow to allow fish and other aquatic animals to cross.

Causeways

Causeways are structures which raise the base of the stream bed. They allow water through a culvert during low flows but are inundated during floods.

They are:

- Typically located on waterways with intermittent flows, poorly defined drainage channels and semi-permanent pools that provide habitat for aquatic animals.
- Suitable for wide shallow streams with gravel and soft substrate beds when bridge or culvert construction is too expensive and intensive use is not anticipated.

Design requirements:

- Sited on a straight waterway stretch with a minimal gradient perpendicular to the waterway.
- Normal hydraulic regime should be preserved, where possible.
- Provide stable substrate and scour-resistant material immediately downstream (if not tidal).
- Do not site near a riffle or pool.
- 'Key' ends of the causeway into the bank for between three and five metres.
- Construct the causeway surface of erosion-proof material, such as interlocking angular rock or concrete.
- Avoid deep box cuts on the approaches to the causeway.
- Incorporate culverts that adequately provide for fish passage, particularly during low flow conditions.
- Must be low enough to allow fish passage during high flows.

Advantages

- If designed in accordance with environmental requirements, they may be a cost-effective compromise between vehicle movement and fish passage.

Disadvantages

- Can restrict fish movement.
- Poorly sited causeways can lead to erosion of the stream bed and banks.
- A drop caused by erosion may be created on the downstream side of the causeway. This may make it difficult for fish and other aquatic animals to cross.

b) Design of structures for amphibian species

- Refer to Section 7.2: Amphibians for additional species-specific information.
- Design in close consultation with amphibian experts, as different species have specific requirements.

Design requirements:

- Refer to Figures 6.6.7 and 6.6.8.
- Location and design based on expert knowledge of the target species and frog migration routes in the project area.
- Connect known habitat areas, with consideration of current and future land uses.
- Orient culverts along known movement routes, such as those between breeding and foraging areas.
- Average dimensions: one metre high and three metres wide. Length should, preferably, not exceed 30-35 metres.
- Construct a channel through the centre. This holds water during dry periods to encourage amphibian use.
- Allow rain to moisten the substrate within the culvert.
- Line base of the culvert with a natural substrate: earth or humus (amphibians are unlikely to pass through culverts with a concrete base).
- Design variations can include hanging pieces of shade cloth at regular intervals throughout the culvert to provide refuge (Figure 6.6.8). See Section 9.1 Case studies: Tugun Bypass.
- Encourage use by spraying inside of the culvert with water from nearby water bodies (ponds or streams inhabited by amphibians). Note: there must be sufficient water to proceed with this option.
- Fencing:

- Exclusion of adult cane toads from the culverts can be achieved by erecting fine mesh or 500 mm vertical metal at the entrance to the culverts (refer to Section 9.1).
- Frog fencing used in conjunction with culverts to direct and encourage use.

Construction:

- Minimise/avoid impact on the vegetation surrounding culvert entrances. If entrances are severely trampled during construction frog usage may be limited.

Advantages:

- If designed in close consultation with amphibian experts, structures will be effective in allowing movement across a road barrier.

Disadvantages:

- If not designed in close consultation with experts structures are likely to be ineffective.



a)



b)

Figure 6.6.7 a) Frog culvert at Tugun Bypass (Robinson-Wolrath 2007).
 b) Frog culvert at Tugun Bypass with shade cloth installed to provide amphibian refuge (Robinson-Wolrath 2007).

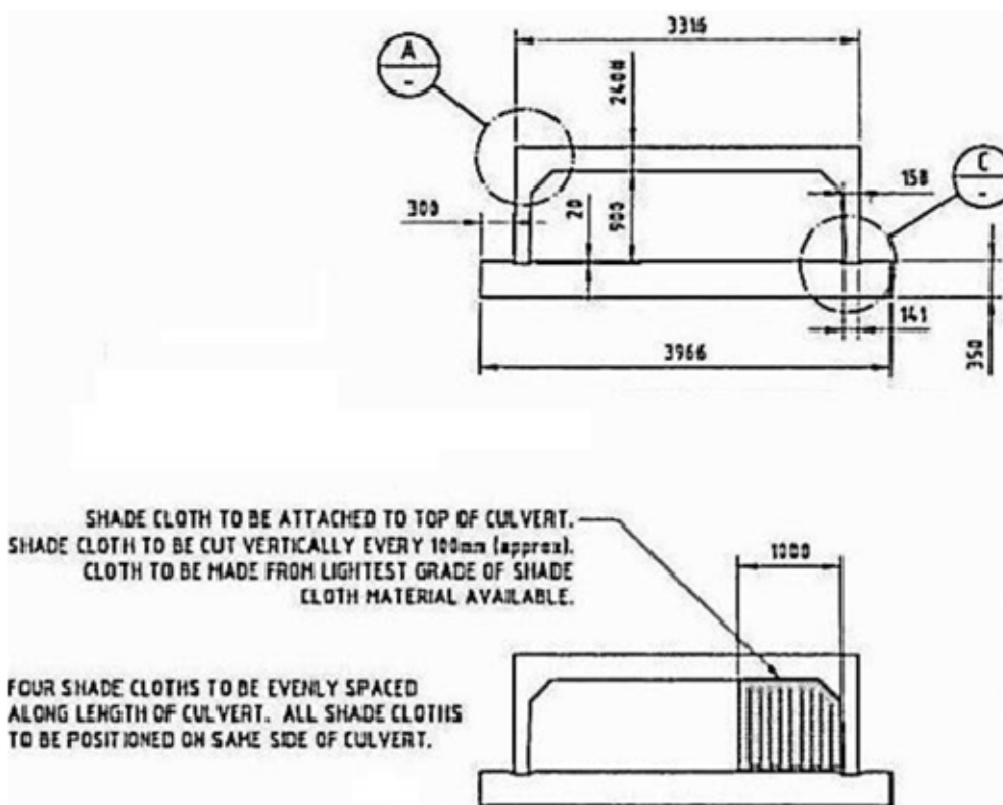

Figure 6.6.8 Cross section drawing of frog culvert adapted from drawing 3003181-DRN- 020-3076 (Pacific Alliance Link 2006d).

c) Design of structures for turtles

Underpasses have been used to link aquatic habitats for turtles (Figure 6.6.9).

In overseas locations, increasing the number of culverts is known to decrease predation at fencing and people stealing turtles as pets (or meat). In these circumstances it is recommended that turtle culverts be placed every 200-300 metres, although this must be determined in relation to the target species.

A 3.5 metre diameter and 46.6 metre long round corrugated metal drainage culvert has been used in north-western Florida (USA) for multiple fauna species. The specific turtle species targeted were Florida cooters, yellow-bellied sliders and mud turtles (Aresco 2003).



a) Cross-sectional view

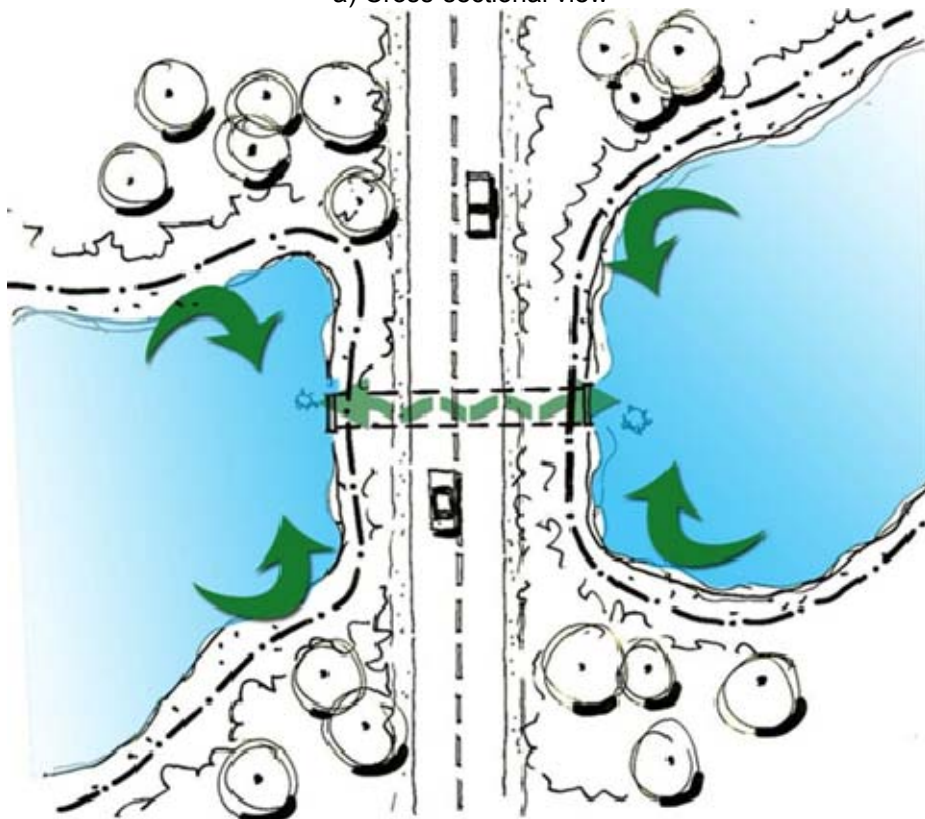

b) Plan view

Figure 6.6.9 Culverts can be used to link turtle habitat disconnected by a road. Guide fencing is shown.

d) Design of Structures for platypus

- Must not have an exposed concrete base:
 - Platypus are known to avoid concrete-based culverts (interferes with their electromagnetic sensitivity) and will risk crossing the road instead.
 - Install bio-baffles to reduce smoothness of culvert.
- Ensure platypus can comfortably enter and exit the culvert.

- Prefer culverts with low flow rate (no more than 2.4 m/second and need to be able to grip onto culvert surface).
- Greater amounts of vegetation cover in and around the culvert are known to be associated with reduced roadkill levels.
- Require stable banks to burrow into, therefore the maintenance of riparian tree roots (such as from Casuarina trees) in the vicinity of the culvert is essential.
 - If possible, revegetate and reconsolidate denuded banks as quickly as possible with native trees and shrubs (for example, Eucalyptus, Casuarina and Callistemon).
- To be constructed in association with appropriate fencing preventing access to the roadway.

Effectiveness:

- Platypus have a 'long term memory' so the structure must be ideal from the start. Poor design has resulted in culvert avoidance even when modifications are made at a later stage.
- Construction recommendations:
 - Construct during the driest part of the year (May – September) and when platypus are not rearing young (April – August).
 - Ensure water flow is maintained at all times.
 - Minimise the time taken for heavy plant operations (for example, pile driving) and if possible confine these to a discrete time period.
 - Minimise the length and width of bank destruction necessary for construction access.
 - Avoid large alterations to bank profiles that may redirect water flow.
 - Avoid compromising stream and bank sections that are preferentially used by platypus.
 - Retain the voids between the gravel and rocks within the natural waterway ensuring aquatic invertebrates are retained.
 - Prevent water pollution, sedimentation and substrate disturbance ensuring the survival of local aquatic invertebrates (foraging resource).

Advantages:

- Encourage natural movement up- and downstream.

Disadvantages:

- If constructed incorrectly, platypus will actively avoid these areas for the long term.
- Electromagnetic fields from culvert supports may interfere with platypus electroreception (Magnus *et al.* 2004).

e) Design of structures for terrestrial species

- Size:
 - The 'Relative Aperture' of a culvert is one method to ensure utilisation of the structure by a large variety of fauna.
 - Relative Aperture = length/opening width or height.
 - Optimal size: relative aperture to be less than eight.
 - 3 metre x 3 metre box culverts are generally considered suitable to accommodate a wide variety of terrestrial fauna species (including macropods, koalas and flightless birds).
 - Minimum vertical clearances between the ground and roof of the structure are chosen to accommodate the targeted fauna species.
 - To encourage the passage of a variety of small to large fauna species, a minimum vertical clearance of three to five metres is considered necessary.

- Size of the culvert must be cost-effective.
- A 3.4 metre high x 3.7 metre wide culvert has been installed for the safe passage of cassowaries in North Queensland (Figure 6.6.10). This structure has a dry ledge with a 'natural' surface. The effectiveness of the structure is uncertain at present.
- For small mammals, pipes or rectangular tunnels should have a diameter/width of 0.4 – 2 metres. This is, however, dependent on the structure's length, openness and the specific target species. A diameter of 1.5 metres or greater is suitable for multiple small mammal species.
- Rectangular tunnels are preferable for small mammals (Figure 6.6.11).
- When constructing pipe structures for small mammals ensure the diameter is large enough to allow the bottom section of the structure to be filled in to provide a horizontal surface.
- Substrate:
 - As natural as possible.
 - Place gravel, mulch or embedded rocks into the bottom of the culvert unless surrounding substrate can be replicated.
 - Openings to lead directly into the habitat (not concrete).
 - Travel of arboreal fauna along bare ground in an underpass increases their vulnerability to introduced predators such as dogs, foxes and cats.
 - Prevent waterlogging and in general provide dry passage for fauna. Koalas require a dry substrate.
 - Roughen surfaces with a gradient.
- Vegetation:
 - Plant entrances with appropriate and potentially palatable vegetation (for example, eucalypts, shrubs and grassy groundcover).
 - Ensure there is a continuum of habitat to the underpass entrance.
 - Although most native fauna prefer complex vegetation structure near underpass entrances (three to 50 metres from entrance), macropods prefer a simple vegetation structure.
 - For macropod corridors include open and closed forest and a mixed vegetation structure.
- Furniture: (Figures 6.6.12 - 6.6.18).
 - Provide a dry ledge or similar within dual purpose culverts. Those without ledges are known to be avoided.
 - Include horizontal and vertical poles and netting attached to pylons where appropriate to target species.
 - Place horizontal logs for passage as high above the base of the opening as practical, allowing 0.6 metre ceiling clearance for fauna passage (Figure 6.6.15a).
 - Vertical logs are secured to the invert of the concrete base slab and soffit of the culvert ceilings by attachment brackets (Figure 6.6.15b).
 - Interconnecting logs can provide a dry passage for koalas whilst also providing refuge from predators.
 - Outside and within the culvert: refuge poles (three metres tall and 200 mm diameter) are effective where introduced predators are likely to attack koalas (Figure 6.6.14).
 - It is important to ensure that the poles are located at least three metres away from koala exclusion fencing.
 - The advantages of using lead-up logs at either end of the culvert for predator use or avoidance is unknown (Figure 6.6.12c).
 - A break in the middle of the culvert (if a median strip exists) is preferred if the culvert is located under a four-lane road.

- Skylights should be avoided as excess runoff, traffic noise and other additional barrier effects can reduce effectiveness of a fauna crossing structure.
- Overlapping rocks and boulders to be placed inside a large opening to provide predator protection for small mammals and/or reptiles.
- Refuge poles and ropes can also be used for animals, such as koalas and arboreal species, for predator evasion (Figures 6.6.12a and 6.6.14).
- General reptile furniture includes tiles, logs, mulching and stones and will increase the likelihood of usage by reptile species. Similar furniture will increase the likelihood of small mammal usage due to increased prey distribution (ie. invertebrates).
- Provide shelter and guidance for small mammals.
- Fencing:
 - In accordance with Department of Transport and Main Roads' Standard Drawings Roads Manual - Standard Drawing 1603: Fauna exclusion fencing.
 - Constructed to guide fauna towards the culvert entrances (Figures 6.6.12b, 6.6.17 and 6.6.18).
 - Construct culvert prior to the erection of permanent fencing.
 - Conventional fencing is unsuitable when small mammals are part of the target species.
 - Wire-mesh size and height must be adapted to prohibit these species from the road corridor.
 - See Section 6.11: Barriers: Fencing for additional fencing information.
- General:
 - Ensure that underpass entrances lead to natural habitat on both sides and that this view is visible from culvert entrances.
 - The installation of several underpasses at one location decreases the possibility of interference caused by other fauna movement (species interactions), provides alternative routes to bypass predators, decreases travel time to find safe crossing and enables more equal population distribution.
 - Minimum gradient of 1% and a maximum gradient of 1:2 for small mammal species. This is, however, dependent on the target species.
 - Ponds, cleared areas and noise near underpass entrances were found to discourage use by macropods.
 - For macropods, dry passage at all times within the culvert must be provided. Culverts that do not provide a dry crossing are known to be avoided.
 - Long and narrow underpasses deter macropods.
 - Appropriate height of a culvert for macropods will be influenced by gait behaviour.
 - Eastern grey kangaroos can utilise 3 metre x 3 metre box culverts (Australian Museum Business Services 2001).
 - Red-necked wallabies are known to use box culverts 3 metre x 3 metre and 800 mm diameter purpose-built arches (Australian Museum Business Services 2001).
 - Swamp wallabies can utilise box culverts 3 metre x 3 metre, 1.2 metre x 2.4 metre, and 2.8 metre diameter purpose-built arches (Australian Museum Business Services 2001).
 - Small culvert usage tends to be dominated by small mammals, with these species preferring established culverts.
 - Keep entrances free from human disturbance and avoid artificial light.
 - Provide unobstructed access.

Table 6.6.3 Table of considerations when designing a macropod underpass.

Structure	Considerations
Underpass location	<ul style="list-style-type: none"> • Construct at regular intervals. • Ensure that there are a sufficient number of underpasses to allow escape crossings, especially during fire. • Investigate repetitive macropod movements before installing fauna structures. • Locate fauna structures at locations with highest rates of roadkill.
Culvert	<ul style="list-style-type: none"> • Either end of culvert must be clearly visible. • Take measures to reduce water pooling. • Include at least one ledge or similar for dry crossing. • Avoid lights within culverts.
Underpass flooring	<ul style="list-style-type: none"> • Concrete floors had higher rates of crossings by echidnas, wallabies, kangaroos, possums and water rats than koalas. • Encourage sedimentation of flooring for a more natural environment. • Take measures to avoid water pooling.
Size	<ul style="list-style-type: none"> • Macropods and koalas prefer underpasses with large diameters. • Refer to above section discussing optimal 'Relative Aperture' dimensions. • 3 m x 3 m box culverts are preferable for macropod species. • Underpasses with height smaller than the width are more commonly used by fauna. • Lengths longer than 20 m have generally lower use.
Furniture –lights	<ul style="list-style-type: none"> • Open skylights may cause noise and other associated pollution issues. • May encourage vegetation growth.
Furniture – refuge poles	<ul style="list-style-type: none"> • Provides safety for koalas. • May encourage underpass use by koalas.
Furniture – ledges	<ul style="list-style-type: none"> • Favoured by smaller fauna although koalas do utilise them. • Place in the top two-thirds (towards the roof) of the underpass. • Ensure slope at both ends of the culvert is 1:5 or vertical to ensure that predators are unable to utilise the ledges (research is required to determine the ideal slope if any).
Silt traps	<ul style="list-style-type: none"> • Discourage fauna use when located near underpass entrances.
Fencing	<ul style="list-style-type: none"> • Install to ensure fauna are protected from predators/pests/disturbances. • Ensure that fencing does not trap animals, especially during fire. • Ensure that fencing guides fauna towards the underpass.
Vegetation	<ul style="list-style-type: none"> • Underpass openings need to be vegetated. • Provide forest structure to cater for needs of all fauna. • Allow access to, and view of, entrance and exit.

Advantages

- Utilised by a wide variety of fauna.
- Provides new habitat, unlike some other structures which merely serve to connect habitats.

Disadvantages

- Success is determined by several variables (for example, size, vegetation, furniture, guide fencing, clearance).
- Can be expensive.
- At present, dual purpose culverts in Queensland designed to accommodate drainage and fauna passage have had problems. Currently, may be better to have separate drainage and fauna movement structures.
- Due to the size of some culverts designed for small mammal movement, maintenance can be difficult.
- If there is an insufficient openness of the culvert, vegetation provided within the structure will deteriorate.

Maintenance Requirements

- Ensure vegetation establishes.
- Ensure vegetation consists of diverse species and heights.
- Control weeds and silt buildup.
- Maintenance should occur at least once a fortnight during construction and be ongoing.
- Maintain furniture.
- Undertake inspection of entrances twice a year to ensure access for fauna.



a) Entrance for culvert and showing relative height of passage



b) Ledge for dry passage within the culvert

Figure 6.6.10 Underpass with a ledge to provide dry passage for cassowaries, Mission Beach, Queensland (Scott 2007).

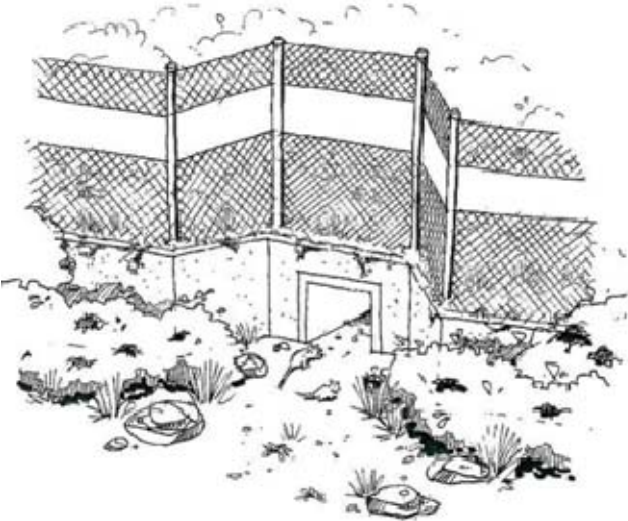
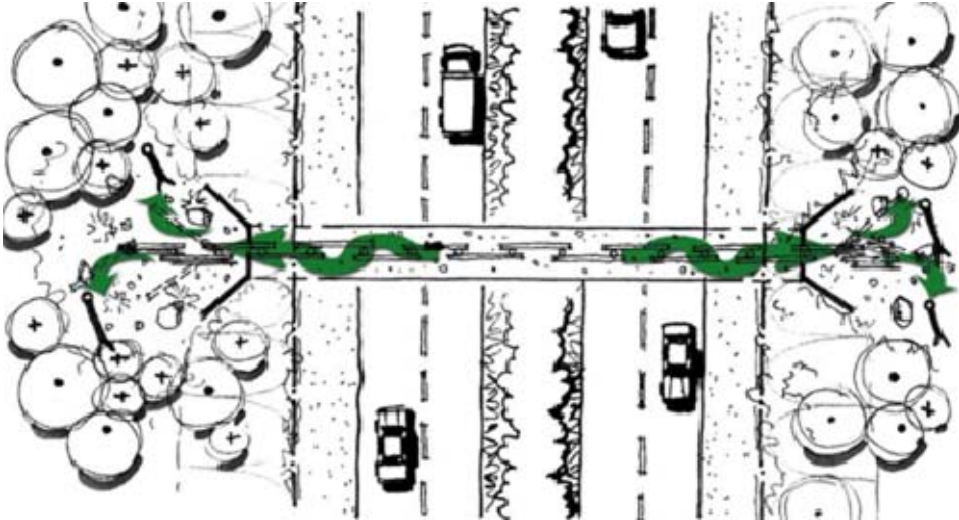

Figure 6.6.11 Small mammal culvert design.



a) Cross-sectional view



b) Plan view



c) Simplified entrance drawing

Figure 6.6.12 Diagram of general fauna culvert with furniture that can accommodate koalas.

Note: optional extensions (lead-ups) on either end of the horizontal furniture logs.

Note: fauna exclusion fencing is used to guide fauna into culverts ('straight' fence design) (Figure b).



Figure 6.6.13 Lead up pole to a horizontal log used to traverse the culvert at a safe height (Robinson-Wolrath 2008).

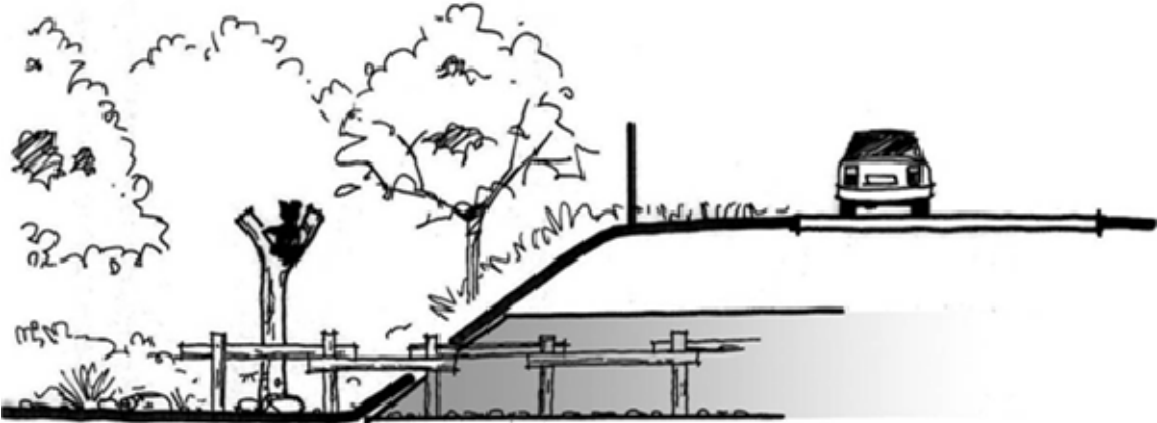

Figure 6.6.14 Refuge pole being utilised by a koala at the entrance to a culvert.



a)



b)

Figure 6.6.15 a) Fauna underpass from Bonville Upgrade (NSW Roads and Traffic Authority project) indicating required height for horizontal logs (Robinson-Wolrath 2008).

b) Brackets used to affix vertical logs to underpass base, used on Yelgun to Chinderah project (NSW Roads and Traffic Authority project) (Robinson-Wolrath 2008).



a)



b)



c)

Figure 6.6.16 Different types of fauna underpasses Compton Road, Brisbane (Scott 2007).

a) East Evelyn Range, North Queensland (Scott 2007). Trawler ropes were installed to accommodate arboreal movement.

b) Yelgun to Chinderah, northern New South Wales. Designed to accommodate a number of species, including birds.

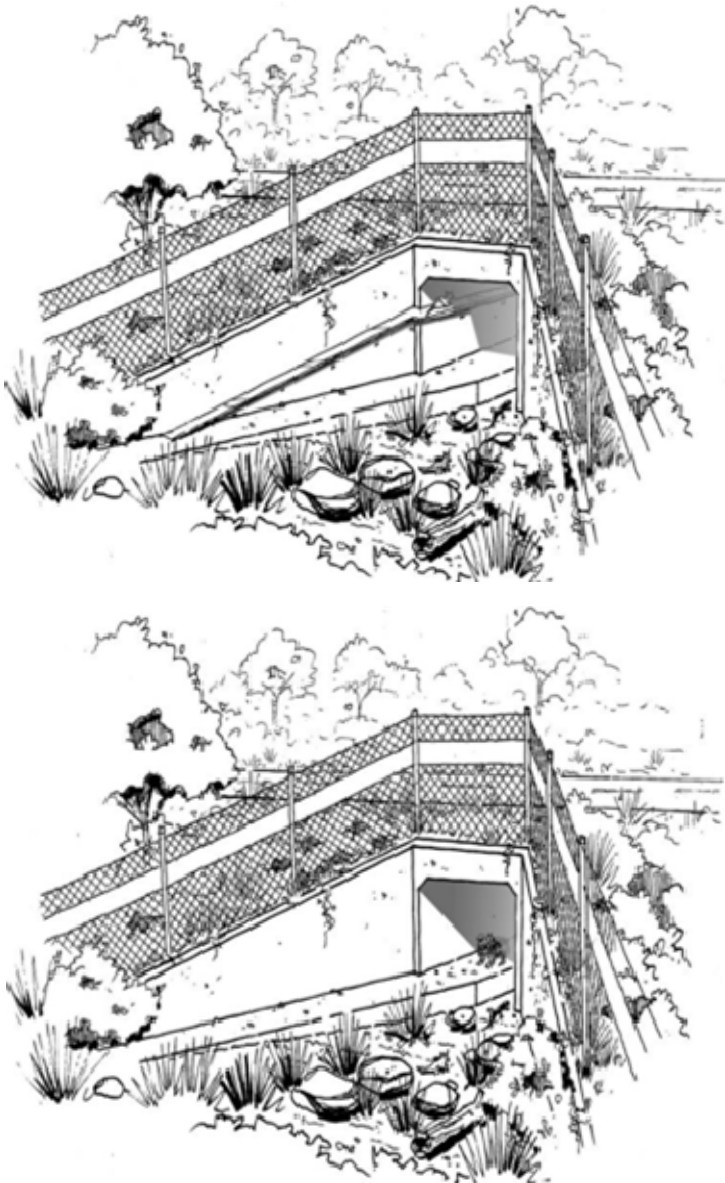
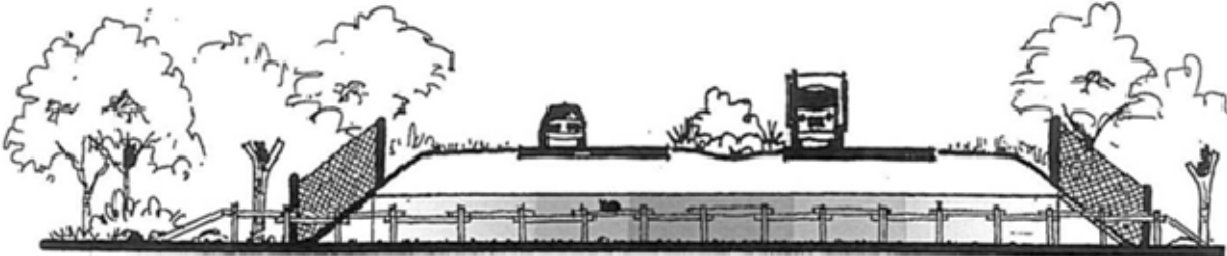
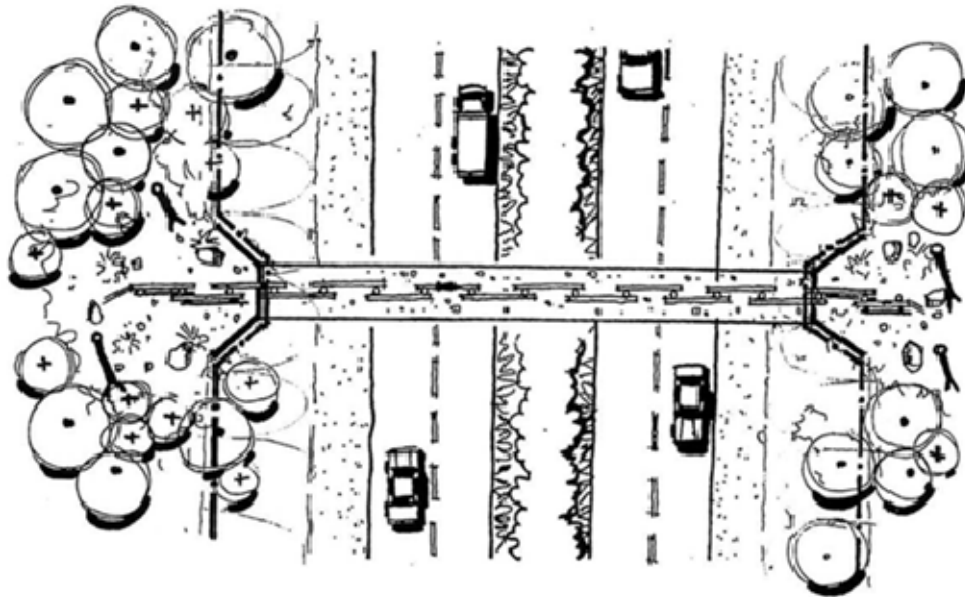

Figure 6.6.17 Furniture used to encourage underpass use by multiple species.



a) Cross-sectional view



b) Plan view

Figure 6.6.18 Fauna exclusion fence installation used to guide fauna to culvert entrances ('jagged' fence design).

f) Design of structures for bats

No purpose-built bat structures should be built without contact and ongoing involvement of a bat specialist.

Design requirements:

- Designs are dependent on the target bat species, the environment and the culvert's purpose.
- A general design requirement may be, for example:
 - 1.5 to 2 metres in diameter.
 - Of sufficient length to allow enough bends to prevent light from reaching the main roosting site (Figure 6.6.19).
 - If only one bend is to be constructed, it should be sufficient enough (approximately 30 – 40 degrees) to ensure darkness at the roosting site.
 - Have height variation along its length and at least two entrances, preferably at different heights.
 - If this is not possible or the aim is to simply provide a roosting site then driving a culvert into a pile of fill may also be suitable if designed appropriately.
 - Roosting sites have been constructed utilising concrete culverts, pipes and tyres.
 - Construct the roost area out of rough rock or have the roof of the roosting area roughened.
 - A carefully-designed fence at the entrance may be required to keep people out. A sign may be provided to inform the public why access is denied. Design the fence appropriately to ensure bat access remains.
- Airflow needs to be established:
 - Two entrances at different levels (preferred option) or a single entrance with the interior of the roosting area to be inclined/declined to create temperature and pressure differentials to establish air flow.
 - Should not be so strong as to create wind, but rather act to facilitate air replacement in the structure.
 - There are no simple design guidelines to achieve appropriate airflow.

- A range of temperature regimes at various points in the structure needs to be created.
 - Designed to accommodate as many different species as possible by establishing a range of different conditions.
 - May be achieved by constructing roof avens that trap warm air and some sections which are low and trap the cold air.
- A high degree of temperature and humidity buffering from the ambient conditions is preferred.
- Structures need to be built to protect bats from predators (rats, snakes and so on). This can be achieved by:
 - Smoothing lower walls of the roost area without any projections from the ground or any shelves.
 - Provision of total darkness, as this may act as a barrier to some predators.
- Construct roosting sites within the structure out of rock (preferred) or a wood material.
 - Steel can rust and cause damage to bats' feet.
 - Steel can act as a conductor of heat and, therefore, transfer heat away from the roost site.
 - Wood material does not last for a long period of time, particularly in the 'underground' environment of a roosting site.
 - Bats prefer to roost on clean surfaces.

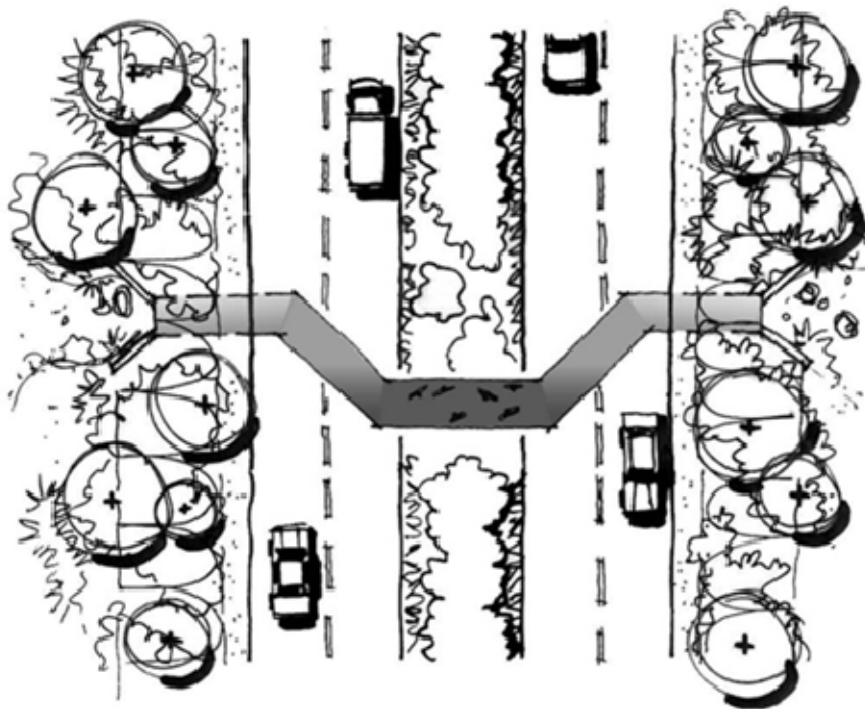

a) Plan view illustrating a possible bat culvert design providing a dark roosting site.

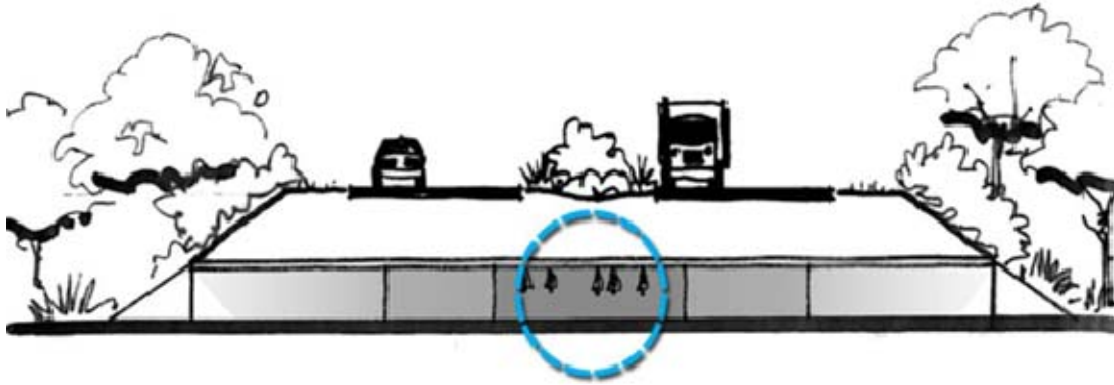

b) Cross-sectional view showing the light gradient created from bends in the culvert.

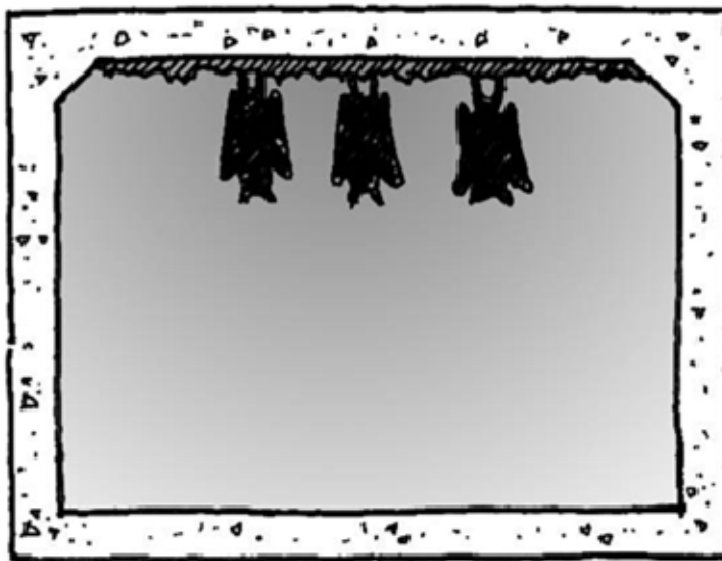

c) Magnified view of a bat roost section (circled in blue in (b))

Figure 6.6.19 Bat culvert. Note the rough roof roosting surface and smooth side walls to prevent predation.

6.7 Underpass: Tunnel

Typically round pipes of relatively small diameter (for example, less than 1.5 metres in diameter). May also be termed an eco-pipe.

6.7.1 Target species

- Small-sized fauna, depending on dimensions, and whether it is wet or dry.
- Limited applicability to medium- to large-sized fauna.

6.7.2 Design specifications

- Refer to Section 6.6: Underpass: Culvert for detailed information on design features to enhance the tunnel's functionality.
- Suitable for aquatic fauna if installed below water level but hydraulic preferences of aquatic fauna must be taken into consideration.
- Only suitable for terrestrial fauna if the tunnel is located in an area that does not experience flooding.

- Design improved when a dedicated drainage pipe is installed alongside a fauna-dedicated tunnel.

6.8 Underpass: Bridge

A structure that maintains the grade of the road or elevates the traffic above the surrounding land, allowing animals to pass under the road (Table 6.8.1). It facilitates water drainage or the movement of local human traffic and secondarily the passage of wildlife.





6.8.1 Target species

- All fauna

6.8.2 Design specifications

- Movement corridors provided under bridges are the most appropriate crossings for sites with threatened species, fish habitat or aquatic vegetation.
- Bridges with no in-stream support sections are the only crossings that pose no physical barrier to fish movement.
- Generally, bridge structures have the least impact on aquatic fauna passage as they normally involve minimal disturbance to the water flow and aquatic habitat.
- Used when frequent fish crossings are anticipated.

Table 6.8.1 Types of bridges.

Single span bridge		No intermediate support pylons
Multiple span bridge		One or more intermediate support pylons
Viaduct		A long multi-span bridge
Grid bridge		Constructed from railway lines and welded beams, with concrete abutments and piers, they range from 6-100 metres in length and are relatively cheap to build.

Design requirements for aquatic species:

- Built to avoid marine plants and/or high value fish habitats, where possible.
- Designed to span the waterway with no in-stream supports, wherever possible.
- Designed and constructed to accommodate all flow conditions.
 - Seek expert advice on a range of issues, including geography, hydrology, hydraulics, geotechnical and geochemical issues and road geometry.
 - Place piers and footings beyond the channel and above the high water mark to avoid constricting the channel and reducing the flow area.
- Need to consider erosion management (aimed at decreasing maintenance costs).
- Use grated decking on a multilane bridge to allow light and moisture to penetrate. Only consider if the risk of pollution from road spills is minimal.
- In the case of multiple lane bridges, a gap between lanes will assist in allowing light penetration under the bridge.

- Skylights are only justified where endangered fish species sensitive to total darkness are present.
- Construct perpendicular to the waterway, where possible.
- Placement should aim to minimise future maintenance requirements.
- Consider future maintenance requirements and associated disturbance of fish habitats with the aim of minimizing maintenance-related disturbance.
- Elevated approach roads across floodplains need to include culvert cells to reduce flooding and to allow fish passage along the floodplain.
- Construction materials to have clean fill, with no potential to leach and pollute waterways.

Advantages:

- Limited disturbance to the environment if designed in accordance with environmental requirements.

Disadvantages:

- Reduces stream stability.
- Can degrade water quality as a result of road runoff.
- Increases flood flow velocities.
- Blockage of fish passage on floodplains caused by elevated approach roads.
- Limited light penetration under bridge affects in-stream and bank vegetation and in turn affects habitat values and water velocities.
- Creates a non-physical barrier for some aquatic species which avoid dark, colder areas during daylight hours.
- Incorrect placement of pylons/footings leads to the creation of eddies, increased water velocity and turbulence which may delay migrating fish as a result of confused flow signals.
- May produce adverse hydraulic conditions due to increased velocities, channel simplification or excessive water surface drops (Kapitzke 2009).

Design requirements for terrestrial species:

- Use grated decking on a multilane bridge to allow light and moisture to penetrate. Only consider if the risk of pollution from road spills is minimal.
- In the case of multiple lane bridges, a gap between lanes will assist in allowing light penetration under the bridge.
- Where terrestrial passage is required under a bridge, all reasonable and practical efforts should be taken to restore and/or maintain continuous riparian cover along the channel banks. This should occur on both banks, but if not practical, then priority should be given to the bank which is more likely to form part of a fauna movement path.
- Where possible, move bridge abutments away from the watercourse banks to increase the opportunity for terrestrial passage along the banks and overbank areas.
- Include culvert cells in elevated approach roads across floodplains to reduce flooding and to allow fauna passage along the floodplain.
- Provide vertical logs cast into concrete footings and attached to underside of bridge or top of arch spans for fauna passage.
- Viaducts provide the most effective form of passage for birds under the road (Figure 6.8.1).
- Viaducts and bridges are suitable for cassowaries.
 - Landscape with cassowary food trees to act as an attractant.
 - Use appropriate guide fencing.
 - Provide dry passage.

- Current design: Revegetated and reprofiled embankments underneath bridge. This has been successful in enabling safe cassowary passage.

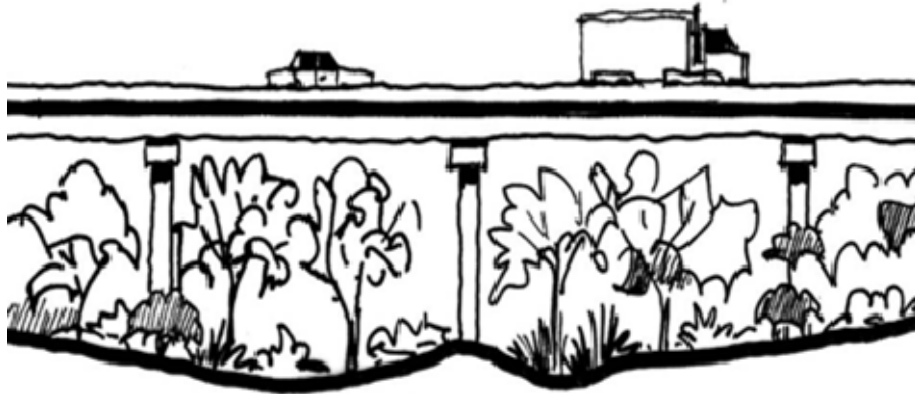

Figure 6.8.1 Viaduct design which can be utilised by bird species.

6.9 Non-structural mitigation: Canopy Connectivity

The width of the linear vegetation clearing is kept sufficiently small to allow the tree canopy to remain continuous, or where not continuous, sufficiently small to allow gliders (and other volant species) to safely traverse the clearing (Figure 6.9.1).



a) Cross-sectional view

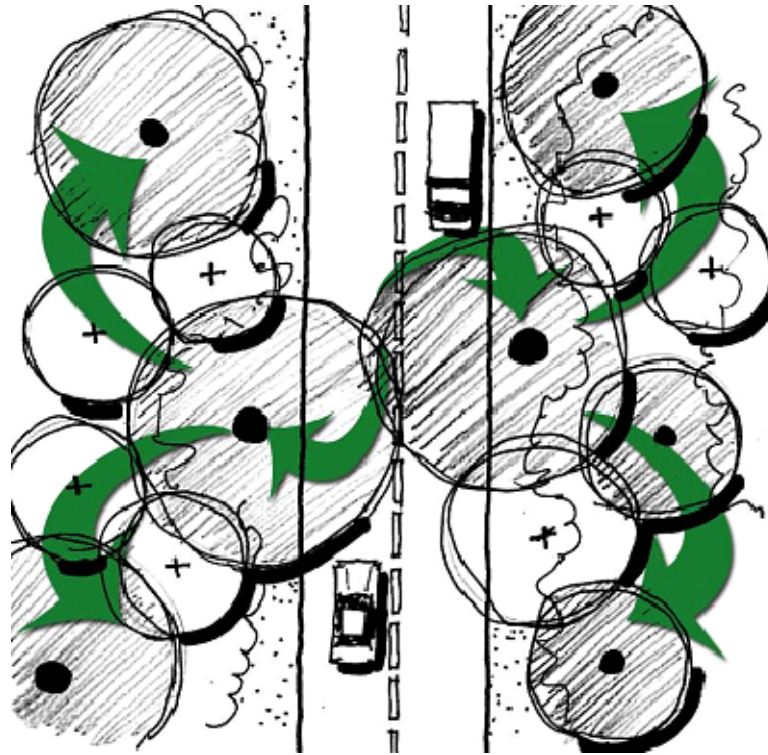

b) Plan view

Figure 6.9.1 Diagrammatic representation of canopy connectivity designed to accommodate arboreal species

6.9.1 Target species

- Arboreal species.
- Flight birds.
- Flying invertebrates.

6.9.2 Design specifications

- Refer to Section 7.4: Arboreal species for additional species information.
- Arboreal species prefer natural canopy connectivity to artificial structures.
- Ensure there is a minimum clearance of seven metres to allow traffic to pass underneath the canopy.
- Retaining a median strip between two carriageways is an effective way to ensure that the target species can pass from one side to the other with relative ease (Figure 6.9.2).
- Ensure final layout and elevation of the carriageway does not alter the drainage significantly to ensure conditions are appropriate for the survival of median vegetation.
- Clear zone and roadside barrier design requirements need to be considered.
- Vegetation:
 - For the Wet Tropics World Heritage Area, it is important to retain median strip vegetation to enhance canopy crossings.
 - Retention of large trees is crucial for glider conservation as these are preferentially chosen for foraging. Large trees also provide hollows, which younger trees cannot supply.

Species-specific information:

- Retaining mature trees with 400-800 mm diameter is not only important for shelter, but also produces flowers more regularly than smaller trees. This is particularly important for feathertail gliders, sugar gliders, squirrel gliders and yellow-bellied gliders.
- Lemuroid ringtail possums are more affected by lack of canopy connectivity than traffic volume.
- Canopy connectivity is also important to small mammals as it reduces edge and linear barrier effects.

Advantages:

- Low maintenance.
- Low cost, if additional land available.
- Preferred by fauna.
- Aesthetically pleasing for motorists.
- Enhances and creates habitat connectivity, allowing migration and dispersion.

Disadvantages:

- Safety issues relating to falling branches or animals.
- Can utilise intact canopy connections only over narrow roads.
- Overhead clearance issues.
- Without fencing, canopy connectivity may encourage fauna towards road-edge.
- Area underneath the canopy (ie the road) may become damp and slippery in tropical areas.
- Costly if land purchase is required.

Maintenance Requirements:

- Maintain necessary overhead clearance.
- Maintain dead and decaying branches in areas adjacent to the road.
- Retain mature trees with 400-800 mm diameter for shelter and foraging resources.
- Retention of large trees is crucial for glider conservation as these are preferentially chosen for foraging and roost opportunities.



a)



b)

Figure 6.9.2 Maintained median strip of mature vegetation to facilitate safe glider migration.
a) Pacific Motorway, Bonville Upgrade, New South Wales Roads and Traffic Authority.
b) Pacific Motorway, Brunswick Heads, New South Wales Roads and Traffic Authority.

6.10 Non-structural mitigation: Local Traffic Management

Local traffic management incorporates devices aimed at reducing the speed or volume of traffic, for example, road closures, chicanes, crosswalks, lighting, signage, rumble strips. These measures raise driver awareness to the presence of wildlife.

6.10.1 Target species

- All species.

6.10.2 Design specifications

- Numerous methods and devices installed to change driver behaviour and result in slower speeds. For example,
 - Bends in roads (Figure 6.10.1).
 - The inclusion of bends in roads and maintaining appropriate vegetation clearing may assist with slowing traffic in areas where fauna cross the road.
 - May alternatively decrease advanced warning of fauna in the road corridor.
 - Chicanes (Figure 6.10.2a).
 - Raised crosswalks (Figure 6.10.2b).
 - Signage (Section 6.10.2a; Figure 6.10.3).
 - Rumble Strips (Figure 6.10.5).
- Most effective in low speed areas.
 - In high speed areas, it is reported that there is not a significant drop in roadkill events after the installation of signage (Coulson 1982).
- Where practicable, maximise visibility of the fauna crossing area in both directions of road traffic.

- Local traffic management measures are most effective when installed in conjunction with other measures of mitigation.
- Permanent and temporary signage has been installed in North Queensland in an attempt to reduce vehicle collisions with cassowaries (Figure 6.10.3).
- The success of permanent signage in reducing roadkill and public awareness diminishes over time, particularly with local residents who are regular travellers on the target roads.
- Reduction in speed limits may have the potential to reduce fauna roadkill. Such mitigation needs to be accompanied by public education and enforcement (policing).

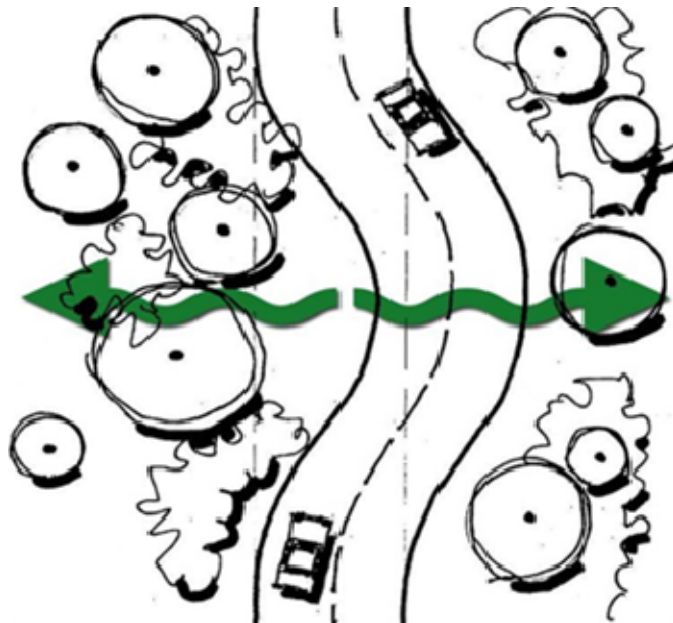

Figure 6.10.1 Roads with bends are likely to increase safe fauna crossings due to decreased vehicular speed.

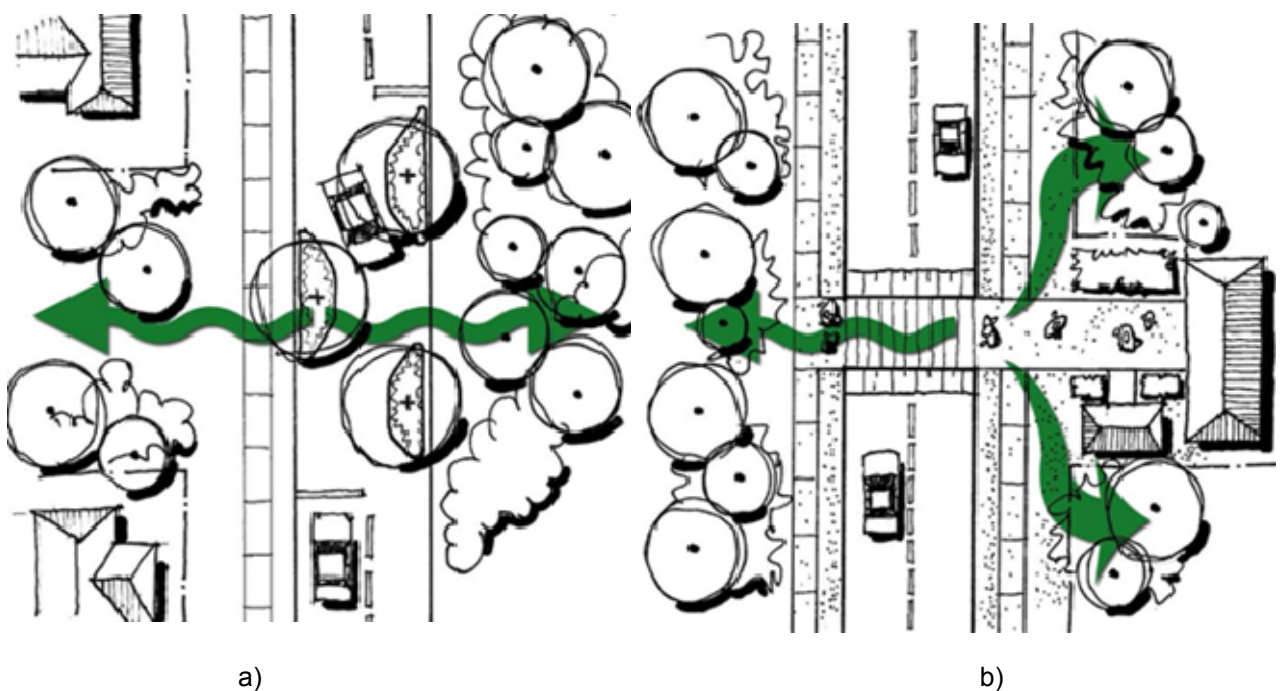

Figure 6.10.2 Diagram showing increased likelihood of safe fauna passage (displayed with green arrows) using:

- a) Chicanes*
- b) A raised pedestrian crosswalk.*



Figure 6.10.3 *Warning sign used to alert drivers to the presence of cassowaries on the road, Mission Beach, Queensland (Scott 2007).*

a) Signage and road markings

- Signs for kangaroos and wallabies are the same. They have a fluorescent yellow background colour to make them more visible at dawn and dusk when these animals are more active (Figure 6.10.4).
- Wildlife corridors do not warrant the installation of significant wildlife conservation areas signs but may be signed (if warranted) using wildlife warning or wildlife information signs.
- Generally, where there is a high risk of local extinction, signs alone are insufficient for mitigation purposes.



a)



b)

**Figure 6.10.4 a) Macropod warning sign, Brisbane, Queensland.
b) Wildlife information sign indicating a wildlife survey area (McKirdy 2008).**

Sign placement

- In areas which are regularly inhabited by macropods (habitat and crossing points that are not seasonal locations).
- Utilise the WILDLIFE (or similar signs) if there are more than two species requiring signs in the same area.
- If animals are expected to cross in an area over 1km long, then a NEXT...km sign should be added (Queensland Department of Main Roads 2007).

Rumble strips

- Rumble strips have been installed in North Queensland as a tool to alert both drivers and cassowaries to changed conditions (Figure 6.10.5).

- Over time their effectiveness is reduced as regular drivers become familiar with the modified road surface.



Figure 6.10.5 Rumble strips on the road aimed at slowing traffic in a cassowary area, Mission Beach, Queensland.

b) Wildlife warning reflectors

Target Species

- Ungulates.

Background

- Originally designed to scare target species from the road corridor by sending vehicular lights into their eyes.
- Manufactured and distributed under the names Swareflex (Austria) and Streiter-Lite (USA).
- Field trials have been undertaken in Australia by Ramp and Croft, as well as the Queensland Department of Main Roads, to determine effectiveness of these reflectors on macropod species.
- Unsuccessful at reducing wallaby and kangaroo vehicle collisions (Ramp and Croft 2006; Scott 2003).
- Animals habituate to reflectors very quickly (Ramp and Croft 2006).

6.11 Barriers: Fencing

Fencing stops animals crossing the road surface, and is used as an integral component aimed at guiding animals towards safe fauna crossing structures or passages.

6.11.1 Target species

- All species, excluding flighted birds, most invertebrates and some reptiles.

6.11.2 Design specifications

- Fencing design shall generally be in accordance with Chapter 8 of TMR's Road Planning and Design Manual (June 2005).
- Type of fauna fencing is dependent upon:
 - Specific purpose;
 - Specific species;
 - Maintenance considerations;
 - Cost-effectiveness;
 - Land use;
 - Topography;
 - Vegetation; and
 - Property access requirements.
- Types of fauna fencing:
 - Fauna exclusion/koala proof fencing (Main Roads Standard Drawing 1603).
 - Refer to Section 6.11.2a
 - Floppy-top fencing (New South Wales standard fauna exclusion fencing).
 - Temporary fencing
 - May be erected or other types of temporary structures put in place when environment/habitats on the roadside are being changed leading to an increase in animal movement.
 - For example, sugar cane burning may result in animal movement across roads and consequently an increase in the amount of fauna roadkill.
 - Construction barriers
 - Erected to ensure animals do not enter the roadway while under construction.
 - Frog fencing
 - Refer to Section 6.11.2b.
 - Refer to Section 9.1 Case Studies: Tugun Bypass.
 - Turtle fencing
 - Refer to Section 6.11.2c.
 - Cassowary fencing
 - Refer to Section 6.11.2d.
- General Considerations:
 - Ensure fencing is used in conjunction with fauna crossing structures.
 - Ensure regular fence breaks if fauna exclusion fencing is installed in areas that do not have crossing structures. This allows for concentrated fauna movement.
 - Necessary to prevent trapping of animals in the case of a fire.
 - Signs may be erected near fence breaks to alert drivers that fauna may be crossing.
 - Fauna exclusion fences may separate a population into less sustainable smaller populations with no provision for recolonisation.
- Extend fencing either side of a safe crossing point to act as a funnel to guide animals (Figure 6.11.1). At least 150 metres is recommended but this is dependent on environmental conditions such as topography and vegetation.

- Include a 'return' design at the end of fencing to direct animals towards the habitat. The return should extend a minimum of 10 metres. Alternatively, placing boulders at the end may encourage fauna to return to intact habitat.
- Construct in conjunction with other fauna mitigation measures and only after other fauna mitigation measures have been completed.
- Provide exit points to enable animals caught within the road corridor access to the adjacent habitat.

Advantages:

- Fauna are unable to cross the road, eliminating the chance of vehicle collision.
- Designs have been trialled, tested and monitored extensively, confirming their efficacy.

Disadvantages:

- Regular maintenance required.
- Maintenance costs.
- Without 'returns' success cannot be guaranteed.
- Has the potential to trap fauna in the event of fire.
- Fauna exclusion fencing alone, while reducing roadkill, may be more detrimental in negating dispersal than the road acting as a barrier.

Maintenance Requirements:

- Maintenance needs to occur regularly and for perpetuity.
- Failure to maintain fauna exclusion fencing may result in animals climbing over or through weaknesses in the fencing.

a) Fauna exclusion/ koala proof fencing

- Refer to Section 7.5: Koala.
- In koala habitat areas the fence must comply with Main Roads Standard Drawing 1603.
 - Barrier to most fauna.
 - Guide fauna towards crossing sites.
 - Sheet metal must be above wire (at the top of the fence) such that the selvages are positioned below the top of the sheet metal strip (Figure 6.11.2).
- Exclude fauna from the road corridor but allow them to escape from the road.
 - Large tree stumps, build earthen berms or escape poles on the roadside of exclusion fencing can be utilised to allow fauna to escape the road corridor.
- Conduct surveys of routes, paths and home-ranges of fauna before installation of fencing and escape structures. Fencing should account for repetitive pathway behaviour, as many species are averse to changing paths and will try to use the same path even if it is blocked.
- Implement measures to stop animals entering the road at the end of fauna exclusion fencing resulting in fauna roadkill hotspots. For example fence 'returns' (Figure 6.11.1).
- Must be installed with knowledge of other fauna which may impact upon the design of fauna fencing (such as amphibians).
- Construct metal flaps at the base of fencing where the fence crosses drainage lines to ensure fauna cannot pass under the fence at these points (Figure 6.11.3).
- Plastic strips at the bottom of fauna exclusion fencing may be used to stop the movement of small to medium-sized reptiles onto the road (Figure 6.11.4).
- Habitual climbers, such as carpet snakes, will not be stopped by generic fences. Specifically designed fencing with smaller openings will be required.

- If bandicoots are within the project area fauna exclusion fencing needs to be constructed from fine galvanised wire mesh or other material with gaps no larger than 20 mm. The foot of the mesh is to be buried to a depth of at least 150 mm and rise at least 500 mm above the ground (Department of Environment and Climate Change 2002).
- Fencing for guiding koalas to fauna structures (such as underpasses) can be configured in two designs:
 - Straight design. This design does not tie into the entrance to culvert or alternative fauna structures. This is less preferred as it can create predator traps and requires more maintenance.
 - Jagged fence design. This design ties into the culvert entrance. This is the preferred design.
- Koala exclusion fencing must have a three metre buffer free of vegetation (excluding grasses) on habitat side of the fence (Figure 6.11.5).

Advantages:

- Metal sheets can be attached to any type of fence.
- More secure and economical than other forms of fauna exclusion fencing.
- 100% success rate at keeping koalas off roads when maintained.

Disadvantages:

- Requires regular maintenance to ensure no vegetation growth.

Maintenance Requirements:

- Must maintain a three metre buffer on the habitat side of the fence, free of vegetation (excluding grasses) (Figure 6.11.5). Buffer area must not have any vegetation that could be used to climb over the fence.
- Vegetation from the roadside should be maintained to ensure it cannot be utilised to access the road corridor (for example, remove overhanging branches, creepers, etc.).
- Maintenance/inspections should occur once a week and be ongoing.
- Maintenance vehicles only require a 1.5 metre clear zone on the habitat side of the fence for access purposes.

Self-closing gate

- Allows koalas to pass through the gate from the roadside, after which the gate is designed to automatically lock to prohibit re-entry to road.

Advantages:

- Allows safe escape from road.
- Able to be used by a variety of fauna.
- Inexpensive.
- Does not affect efficacy of fence.
- Reduces roadkill.

Disadvantages:

- Not all koalas are able to use gates because their weight and height is not sufficient.

One-way fence

Design Requirements:

- Enables koalas to pass from the roadside, through fauna exclusion fencing, by means of a 'drop-down' to the safe side of the fencing (Figure 6.11.6).
- The break in the fence is designed in conjunction with guide fencing to the return drop (Figure 6.11.6).

- The purpose of the structure being a 'drop' is to ensure fauna are unable to climb over from the habitat side of the fence, that is, a one-way fence (Figure 6.11.7).

Advantages:

- Simple.
- Effective.

Disadvantages:

- Requires continued maintenance.

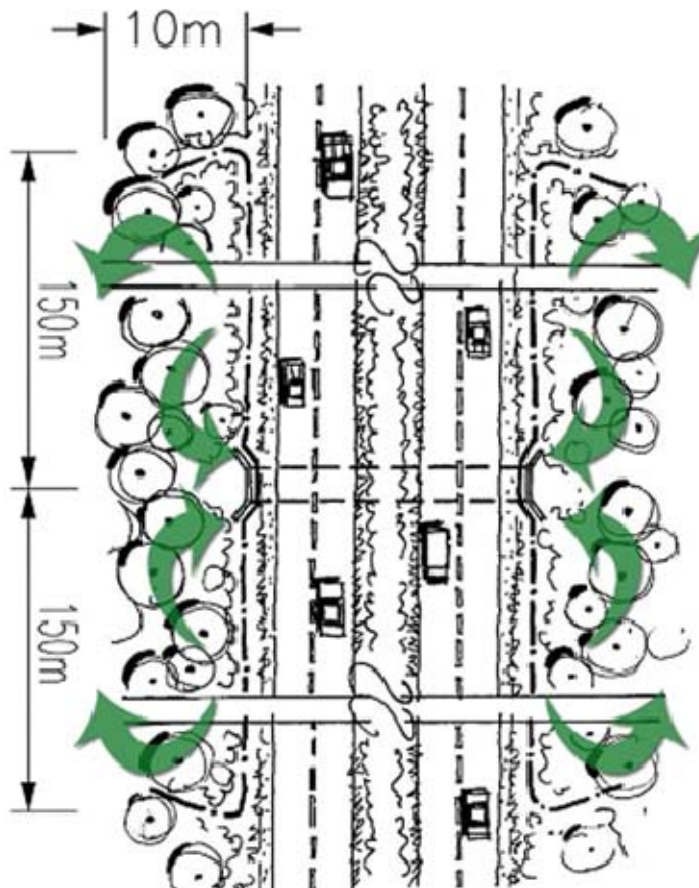

Figure 6.11.1 Optimal design of fauna exclusion fencing on either side of a crossing structure with incorporated returns at both ends.



Figure 6.11.2 *Incorrectly installed fauna exclusion fencing. For correct installation details refer to Main Roads Standard Drawing 1603.*



Figure 6.11.3 *Flap joined to the bottom of fauna exclusion fencing to prevent fauna penetrating road corridors at drainage line.*



Figure 6.11.4 Plastic strips at the base of fauna exclusion fencing can be used to prevent movement of reptiles into the road corridor (Scott 2007).



Figure 6.11.5 Fauna exclusion fencing (floppy top) with a three metre clearance buffer on vegetative side, Bonville Upgrade (Roads and Traffic Authority) (Robinson-Wolrath 2007).



a)

b)

Figure 6.11.6 One-way fence to allow koalas to escape from the road corridor.
a) Photo taken from the drop-off side of a one-way fence located at Yelgun to Chinderah section of the Pacific Motorway (NSW Roads and Traffic Authority).
b) The ramp leading up to the drop-off side of the fence.

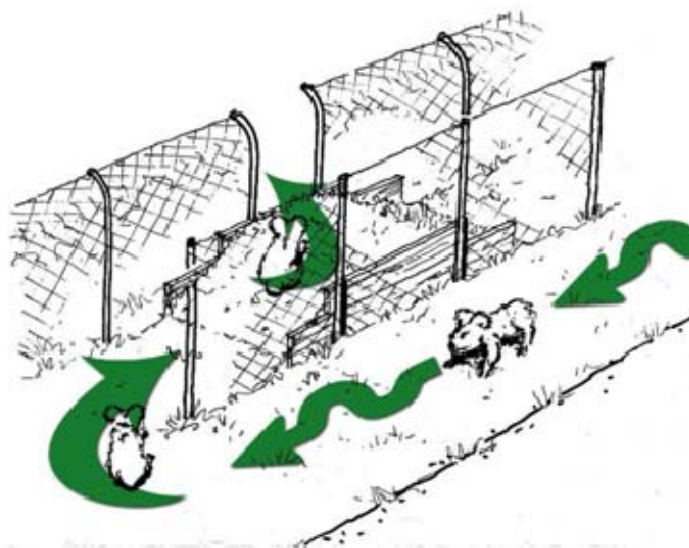

Figure 6.11.7 Use of a one-way fence design by koalas to escape the road. If not using floppy-top fencing, attach sheet metal in accordance with Main Roads Standard Drawing 1603.

b) Frog fencing

- Prevents the movement of amphibians across the road but also directs them towards culverts providing safe passage.
- Design in close consultation with amphibian experts as different species have different requirements.

General frog fence

- Currently being monitored for effectiveness.

- Consists of a 5 mm insertion rubber clamped to a galvanised backing plate then attached to a chain wire fence. The current design is 400 mm high with a 150 mm wide sloped roof to discourage amphibian access (Figure 6.11.8).
 - Expected minimum lifetime of 20 years.
- Can be attached to other fauna fencing or security fencing (Figure 6.11.9).
- Construct using:
 - A solid sheet of durable rubber (insertion rubber) which reaches approximately 400-500 mm high.
 - The insertion rubber is chosen for its durability, availability and the length of the rolls (50-100 m) supplied.
 - Recycled plastic planks (200 mm x 40 mm x 3 m)
 - Recycled plastic posts:
 - one at each end of the planks (75 mm x 75 mm x 1200 mm)
 - a post at mid-span (50 mm x 50 mm x 1200 mm)
 - Construct the roof (155 mm at an angle of 45 degrees from the planks) and lip (30 mm at an angle of 45 degrees from the 'roof') of pre-fabricated galvanised sheets (1.2 mm). This is attached to the top of the planks.
 - Purpose of using recycled plastic planks and posts:
 - Long term durability;
 - Do not require painting or sealing;
 - Made from recycled products;
 - Installed using manual labour; and
 - Easily repaired using hand tools.
- Set fence 60-100 mm into the ground to prevent movement under fences.
- Clear vegetation one metre on either side of the fence.
- Angling the fence toward culvert entrances has been found to be more effective than being constructed parallel to the road.

Temporary frog fence

- Used during construction (Figure 6.11.10):
 - Shade cloth set into the ground and attached to reo hooks.
 - Issues have arisen with durability and the cost of maintaining this form of temporary fencing.

Untried barrier fence

- Concrete drainage-like ditch alongside the fence (vegetated side). Frogs have a strong preference to avoid concrete surfaces, therefore a sufficiently wide and deep ditch may hinder movement towards the fence itself. This structure should not be used for drainage per se, and if it is, a mesh of some sort must be placed above water level to prevent frogs utilising the structure to breed after rain.

Maintenance Requirements:

- It is imperative that vegetation remains clear of both sides of the frog fence.
- Ensure there are no breaches to the fence.
- Maintenance checks should occur on a regular basis.

Advantages:

- Avoids roadkill of amphibians.

- Encourages amphibians to utilise dedicated amphibian culverts in order to maintain population connectivity.

Disadvantages:

- Ongoing and regular maintenance is vital for its effectiveness.
- The current temporary construction frog fence design has had durability and maintenance cost issues.

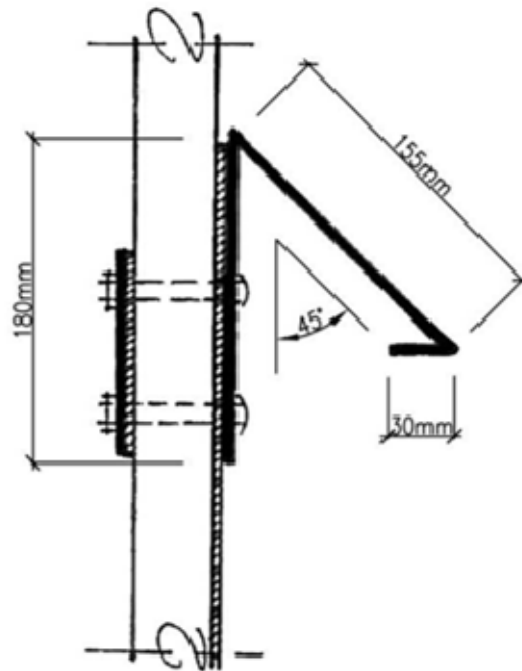
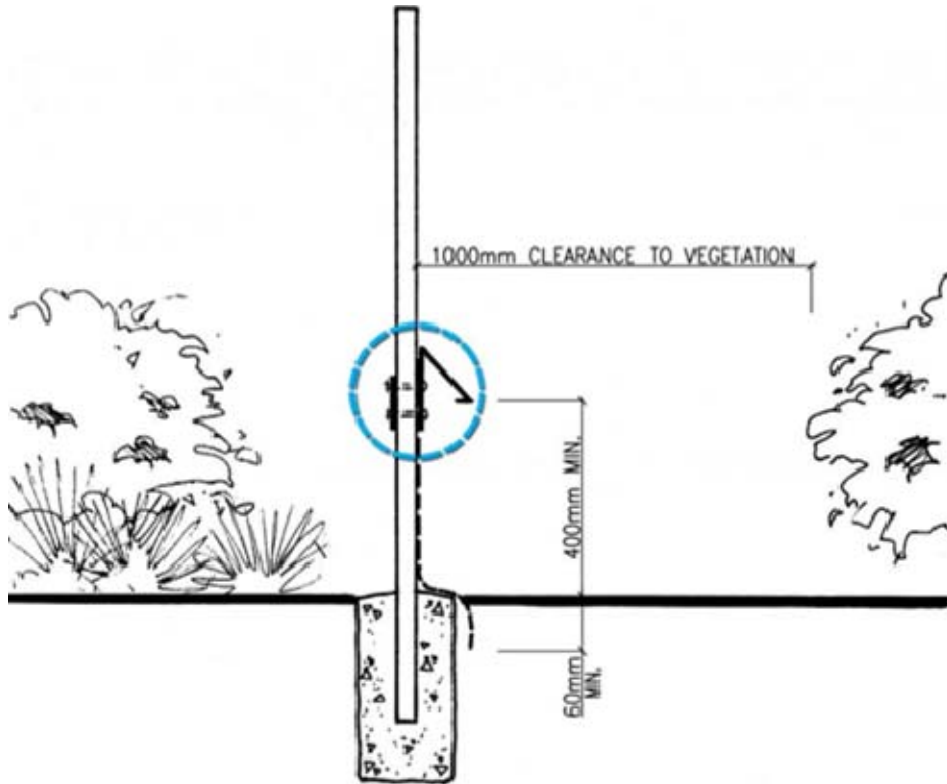
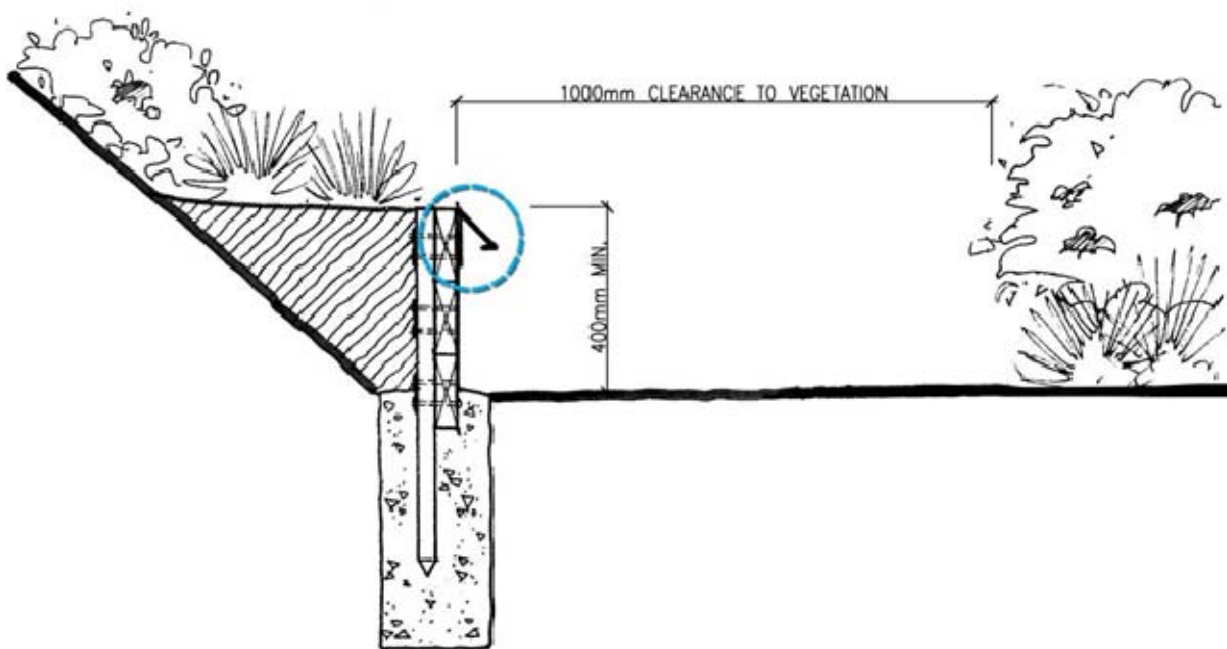

Figure 6.11.8 Cross-section of frog fence design (adapted from 3003181-BFF-020-6003) (PacificLink Alliance 2006d).



a)



b)

Figure 6.11.9 a) Frog fence attached to an existing fence (adapted from 3003181-BFF-020-6003) (PacificLink Alliance 2006d).

b) Free-standing frog fence (adapted from 3003181-BFF-020-6003) (PacificLink Alliance 2006d).



Figure 6.11.10 Temporary frog fence, Tugun Bypass (Robinson-Wolrath 2007).

c) Turtle fencing

The design for turtle fencing has been sourced from overseas situations. The applicability of the design to Australian turtle species has been untrials.

- Designed to divert turtles away from the road and through a turtle-specific culvert.
- 600 mm high woven vinyl erosion control fencing with pre-attached wooden stakes. Preferably installed at the edge of the mowed road corridor.
- The bottom edge of the fence must be buried 200 mm. The above-ground height of the fence is thus 400 mm.
- The ends of the fence should be turned back gradually towards the water at least 80-100 metres.
- Single-entrance screen funnel traps have also been used.

d) Cassowary fencing

- Constructed to direct cassowaries to fauna crossing points (Figure 6.11.11).
- Constructed of shade cloth to inhibit view of habitat on other side of the road (Figure 6.11.12). If habitat on other side of road is visible through fence, cassowaries will attempt to pass through fence and often end up becoming entangled.
- Space underneath the fence allows small mammals to pass through and enables easy access for slashing machinery.
- Vertical gaps in the fence allow cassowaries trapped on the road to be directed to the habitat side.
- Signage to be placed at the end of the barrier fence to alert drivers to the presence of potential cassowary crossings.
- The effectiveness of the current fence design to guide cassowaries to installed fauna crossing structures is unknown and the desire to fence large portions of the road corridor to ensure effectiveness may not be appropriate.

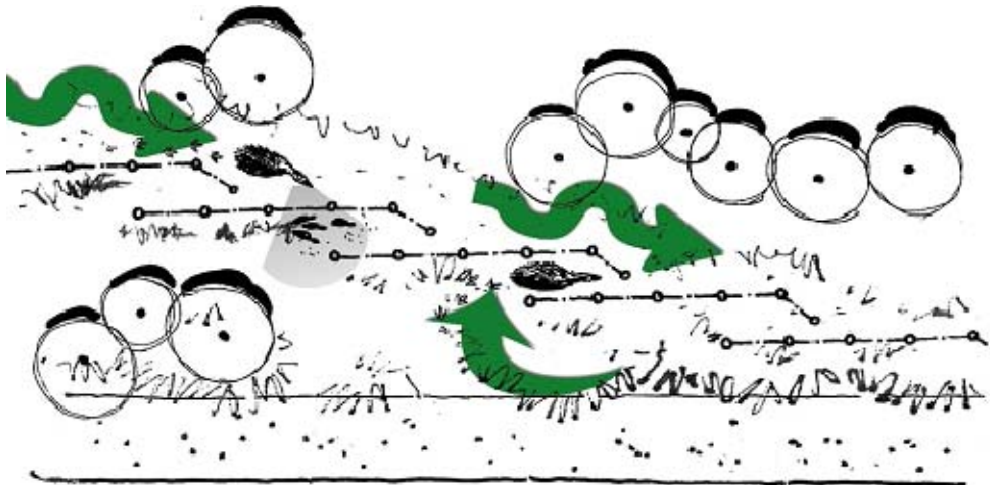

a) Detailed fence design

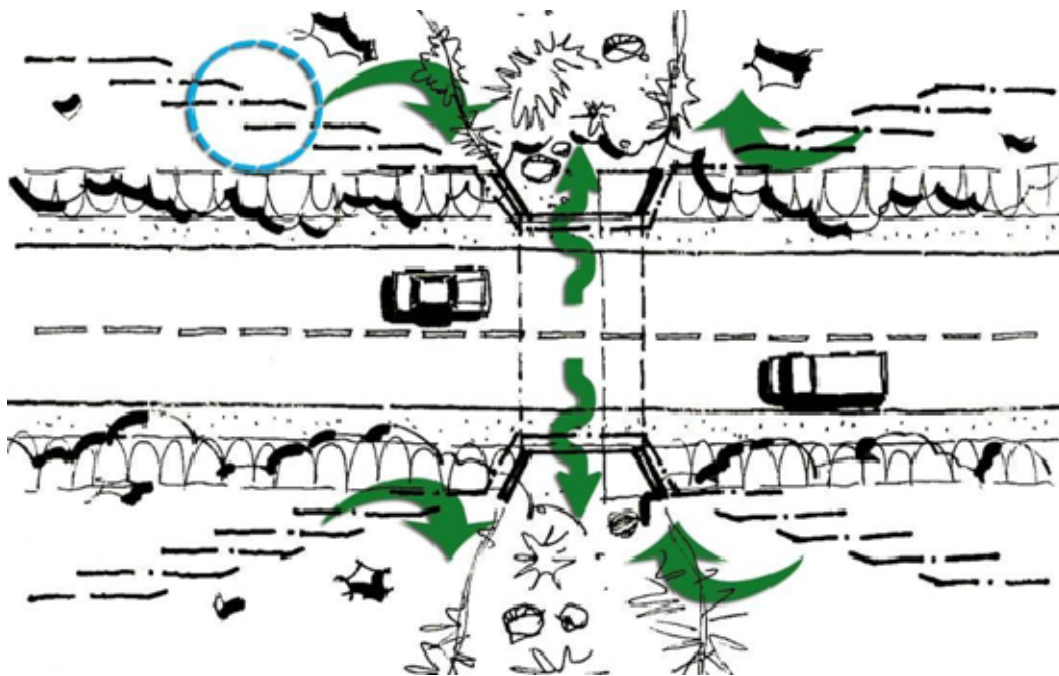

b) Overview

Figure 6.11.11 Cassowary fencing guiding birds towards the safe fauna crossing structure.



a) Cassowary fence position in relation to the road (on left hand side of the road).



b) Detail of fencing with shade cloth and gap at base

Figure 6.11.12 Detail of current cassowary fence design with escape gap.

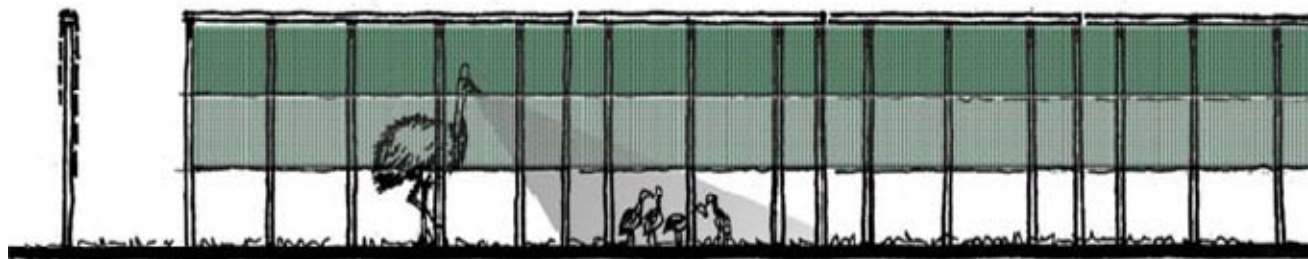

Cross-sectional view

Figure 6.11.13 Space underneath the fence allows small mammals to move through the broader landscape.

6.12 Barriers: Chemical Repellents

6.12.1 Target species

- Macropods.

6.12.2 Design specifications

- Species-specific effectiveness and responses are varied. For example, the pademelon responded to a scent by approaching it to investigate whilst the wallaby fled from it (Ramp *et al.* 2005).
- Temporary use may be appropriate. This will reduce the likelihood of habituation to the scent.
 - For example, could be used while maintenance crews mend gaps in fauna exclusion fencing.
- Case study:
 - Tested the response of western grey kangaroos to the urine of dingoes, which initiated a flight response, while human urine initiated no response (Parsons *et al.* 2007).

6.13 Barriers: Perching Deterrents

Birds perching above roads can cause a hazard when excretion lands on passing cars. The installation of perching deterrents on road furniture, such as light poles, can reduce this risk.

6.13.1 Target species

- Birds.

6.13.2 Design specifications

- 'Spider' deterrents fitted to the top side of lights (Figure 6.13.1).
- Light poles designed to deter pelican roosting opportunities (Figure 6.13.2)
- A bird deterrent wire attached to the gantry cross bar, with associated bird perches constructed to extend three metres out from the gantry (Figure 6.13.3).
- Case study:
 - Pelicans along the Houghton Highway (South-east Queensland) rest on the top of light poles causing a hazard when their droppings landed on windscreens of motor vehicles and visors of motorcycle riders.
 - Mitigation:
 - 'Spider' deterrents have been retrofitted to the top side of lights.
 - A bird deterrent wire attached to the gantry cross bar, with associated bird perches was constructed.

- 'Safe' perch structures are to be installed on the new bridge (Figure 6.13.3b).

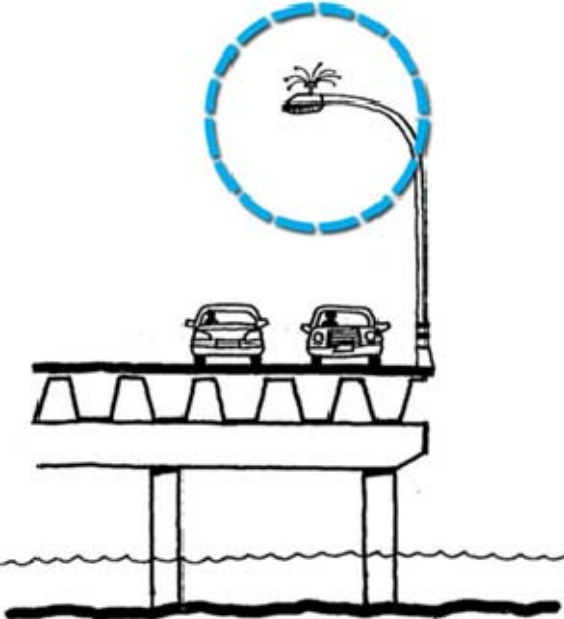

a) Location of spider deterrent on light pole

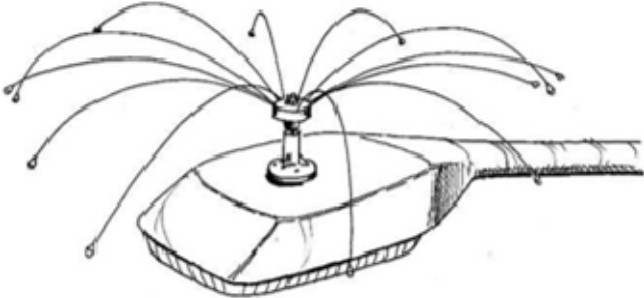

b) Detailed view of spider deterrent

Figure 6.13.1 Spider deterrent on top of light poles reduces potential hazards from perching.



Figure 6.13.2 Light pole designed to deter roosting opportunities

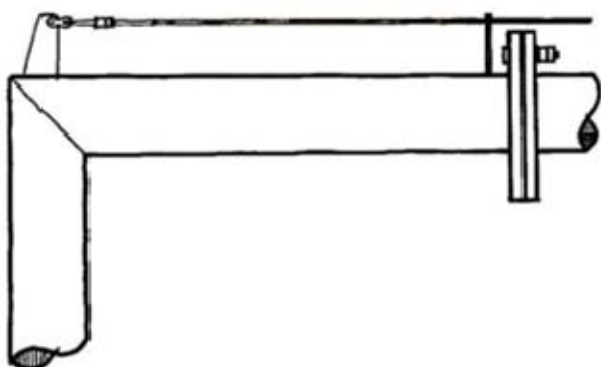
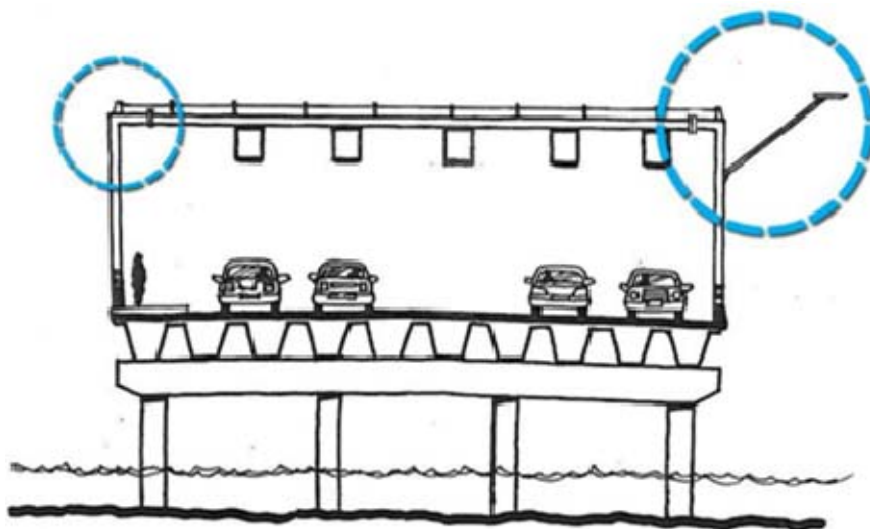

a) Detailed drawing of deterrent wire



b) Detailed drawing of perch structure

Figure 6.13.3 a) Bird deterrent wire on the top of a gantry to stop bird perching.
b) A perch structure installed to provide a safe, hazard free place for perching.

6.14 Habitat enhancement: Frog Ponds

Frog ponds are small constructed ponds and pools aimed at recreating breeding opportunities for target species.

6.14.1 Target species

- Amphibian species.

6.14.2 Design specifications



Figure 6.14.1 Frog pond, Tugun Bypass (Robinson-Wolrath 2007).

Site selection:

- Consult with local amphibian experts.
- Locate in areas where conditions replicate the species' known requirements. For example, pH, salinity, absence of known predators.
- Site constraints will often dictate the placement and form/shape of the ponds. For example, the approximate design criteria for the wallum sedge frog as part of the Tugun Bypass project (Pacific Link Alliance 2006) was:
 - Minimum of 1.5 metres deep with a gradient sloping to 0.3 metres at pond edges.
 - Approximately 15-20 metres long and 5-10 metres wide.

Timing:

- Construction of ponds must be conducted during a dry period (for example, spring) leading up to a pronounced rainfall event (normally in summer) to enable machinery access to the site with minimal damage and to enhance the likelihood of transplanted vegetation survival.

Site preparation:

- Appropriate preparation of frog ponds is critical to their success.
- The physical and hydrological conditions must match the requirements of the target species.
- Consider:
 - Physical conditions (site topography);

- Soil characteristics, as they play a fundamental role in determining the vegetation community and therefore, habitat potential;
- Hydrology; and
- Outlet control enabling water level control.

Design requirements:

Design in close consultation with amphibian experts.

Specific to the target species.

In some cases, steep sides (as close to vertical as possible) are required to ensure cane toads do not utilise the structure.

Ensure pond is appropriately vegetated.

6.15 Habitat enhancement: Nest Boxes

6.15.1 Target species

- Arboreal species.
- Bats.

6.15.2 Design specifications

a) Arboreal species

Background

- If the tree with roosting/nesting opportunities requires removal it is important to consider replacing this lost resource with a nest box (see Figure 6.15.1) or similar structure in a nearby suitable tree. A ratio of at least 1:1 is recommended.
- When a hollow tree is removed note the species that potentially utilised the hollow to ensure replacement nest boxes are species-specific and appropriate.
- Different species utilise different hollow sizes and thus require different styles of nest boxes.



Figure 6.15.1 *Glider nest box installed in South-east Queensland (Scott 2007).*

Design requirements:

- Height of nest box will determine its use:
 - Install between three and eight metres above the ground. This is dependent on target species and environment.
 - Species-specific information:
 - Eastern pygmy possums are the only species to prefer nest boxes lower than two metres.
- Orientation and general placement of nest boxes must take into account:
 - Rainfall.
 - Sunlight (must provide shade during summer).
 - Probability of human disturbance (avoid installing along walking tracks).
 - Natural nesting habits. Undertake baseline surveys prior to the removal of hollows to determine nest box spacing and orientation.
- Each species requires:
 - A different style of nest box. Collect information from natural hollows before replacements are constructed.
 - Due to competition between exotic birds and native species for nest boxes, construct with entrances that are either covered with a baffle, rear-entry entrances, or have a slit-entrance on base (determined by target native species).
- Density of nest boxes:
 - Species have different nest densities and spacings.
 - Separate individual nest boxes by approximately two to four metres.
 - Clusters of nest boxes to be separated by approximately 20 metres.

- Materials:
 - Nest box wall thickness should, ideally, be a minimum of 30 mm, to provide the greatest resistance to external temperature variation.
 - Plywood: 18-25 mm thick and can be sourced from environmentally-friendly companies.
 - Hardwood: Approximately 30 mm thick and can be sourced from waste products from timber production.
 - Non-toxic organic timber sealer should be used.
 - Metal edging on lid is required to prevent damage by chewing.
 - Internal material does not have to be provided in most nest boxes unless specifically designed for bats.
 - Bats require internal plastic mesh or shade cloth to allow them to cling to or climb within the nest box.
- Dimensions and entrance locations:
 - Internal widths of 80-160 mm and 160-240 mm are most commonly used.
 - Do not use nest boxes with less than 200 mm between the entrance and nest box floor, unless target species requires an entrance in the floor.
 - Entrances can be a hole located:
 - at the front near the top;
 - as a hole on the side near the top; or
 - as a slit on base or hole on back, towards the tree.
- Tree attachment:
 - Preferable to use a strap allowing tree growth, that does not damage the tree.
 - Attached by either wiring directly to the trunk or using wire hooks put through a loop placed around the trunk (easier to remove).
 - The use of metal is not recommended as it can corrode quickly and will cause damage to trees.
- Species-specific details:
 - Feathertail gliders, sugar gliders and phascogales are the most common fauna found in nest boxes (Beyer and Goldingay 2006; Goldingay *et al.* 2007).
 - Brushtail and ringtail possums use nest boxes with an internal volume of 46 900 cm³.
 - Feathertail gliders:
 - Generally prefer small rear-entry boxes, large slit-entrance boxes and wedge-shaped bat boxes, all with 25 mm or smaller entrance diameters.
 - Comparisons between the different designs of nest boxes with small entrances (wedge and non-wedge) have revealed no strong preference.
 - Avoid medium sized rear-entry boxes with 45 mm diameter entrances.
 - Require an internal volume of 3 900 cm³.
 - Sugar gliders:
 - Use nest boxes with small but high entrances (Ball and Goldingay 2007).
 - Greater gliders:
 - Prefer tree canopies so are unlikely to be attracted to nest boxes.
 - Squirrel gliders:
 - Rear entry: 150 x 250 x 350 mm.

- Medium sized rear-entry boxes with 45 mm diameter entrances are also utilised.

- General Design Considerations:
 - An ecologist should be onsite during clearing to ensure that hollows and replacements are removed and reinstated with minimal impact and disturbance.
 - Nest box use is dependent on seasons (except for feathertail gliders) and presence of competitors (Beyer and Goldingay 2006).

Maintenance Requirements:

- Maintain furniture within nest box.
- Remove pests/competitors from nest box.
 - At a minimum, should occur after fires and storms. Frequency of maintenance is otherwise unknown.
- Utilise monitoring information to determine whether location, orientation or any other factors need to be altered.

b) Bats

- Some road crossing structures have been retrofitted with various geometric designs of timber bat roosts. These have usually been installed beneath bridge decks or culvert ceilings.
 - These roosts only provide refuge for bat species that are found in association with water and forage of water.
- The central ceiling areas of long sheltered culverts or the soffit of concrete bridge decks between composite girders is the best location to encourage small bat roosting.
- To reduce human disturbance (if likely) install blackout screens and 'no-go' zones (Figure 6.15.2).
- Case study: Bat roosts have been installed under bridges in New South Wales. However, in some cases, despite careful planning and expert advice they remain unused (Figure 6.15.3).
- Bat droppings are a health hazard. Where provisions are made for bat roosting, such roosts must be well clear of areas requiring maintenance access or human movement.

Advantages:

- Provides a form of mitigation for bats when their natural roosting sites are disturbed.

Disadvantages:

- Requires expert advice to ensure appropriate location for roosts.
- Needs careful consideration about location to ensure health hazards associated with bat droppings are avoided.



Figure 6.15.2 *Blackening screens used to stop any disturbance of areas designated for bat roosting, Brunswick Heads, northern New South Wales.*



Figure 6.15.3 *Timber bat roost under a bridge at Brunswick Heads, northern New South Wales*

6.16 Habitat enhancement: Artificial Shelter Sites

6.16.1 Target species

- Reptiles
- Invertebrates

6.16.2 Design specifications

In selected prioritised locations the use of artificial shelter sites may be used to benefit reptiles.

- Cropped/slashed grass in piles can be used as artificial habitat for reptiles.
- Placement of non-combustible, durable cover, such as roofing tiles or sheet metal, along selected road corridors may be useful. Informal studies have shown these can provide suitable shelter for reptile species. Imperfect 'rejects' of these 'cover' materials can be obtained for minimal cost from manufacturers and demolition sites.

- The placement of artificial shelter sites should not impact on the overall health of the remnant vegetation, thus recommended for existing weedy sites.

a) Pavers and roof tiles

- Used as a technique to restore lost or degraded habitat.
- Dimensions:
 - Large pavers (300-450 mm wide and 50-100 mm thick) with a variety of crevice sizes (up to 10 mm) may be used to maximise the diversity of retreat sizes for snakes and lizards (Webb and Shine 2000) and also create habitat for both juveniles and adults.
 - Invertebrates prefer small crevices.
 - For reptiles, pavers should not be thinner than 5 mm as they become too hot over the summer months.
 - 5 mm thick pavers may be attractive to various species of invertebrates.
- Many invertebrate species prefer habitat created by pavers exposed to sunlight over those located in the shade.

Advantages:

- Inexpensive.
- Long lasting.
- Unlikely to be attractive to rock thieves.

Disadvantages:

- Long term effectiveness remains unknown.

6.17 Considerations which influence effectiveness of fauna structures

The effectiveness of fauna mitigation structures varies between locations and is likely to be species- or species-group specific. Nevertheless, there are certain aspects of their design that can strongly influence their effectiveness and should be considered.

6.17.1 Aspects that positively influence rates of fauna structure use

- Funnelling of fauna (often with the assistance of fencing) through a narrow habitat corridor to a fauna mitigation structure.
- Planted vegetative corridors should mimic the original habitat.
- Abundant and high-quality habitat near to entrance of the structures.
- Dirt or natural substrate floors.
- Large openness ratios (length x width x height of underpass).
- Absence or low rate of use by humans.
- Presence of furniture, such as logs, rocks and vegetation on or in the structure.
- Several structures placed within home-ranges will result in fauna utilising new structures much more quickly.

a) Vegetation management in vicinity of structures

- Abundant and high-quality habitat near to entrance of the structures.
- Careful plant selection (in consultation with experts) to provide habitat opportunities for fauna.
- Appropriate maintenance intervention levels will ensure objectives of vegetation planting are preserved.

- Retention of the existing vegetation in the median or provision of a careful revegetation scheme in the median may assist in mitigating habitat fragmentation.
- b) Density of fauna mitigation structures**
- Dependent upon the target species and the distribution of the habitat types in the area.
 - In some cases, one or more wide fauna passages will be appropriate, whereas other passage issues may be better resolved with a larger number of smaller-scale measures.
 - The behaviour of target species can be used as a guiding factor.
 - Higher density of passages should be provided in natural areas, for example, forests and wetlands, than in densely built-up or intensively-used agricultural areas.
 - However, in areas where there are many artificial barriers due to transport infrastructure or built-up areas, fauna passages can be essential in maintaining the general permeability of the landscape. In such cases, solutions can be integrated with all remaining open corridors.
 - The density of passages in relation to the environmental goals has been poorly studied and requires additional research.
- c) Location of fauna mitigation structures**
- Decisions regarding the location of fauna mitigation structures need to be made on the basis of sound knowledge regarding fauna movements and the distribution of important habitats.
 - Where clearly defined animal trails exist locate proposed fauna mitigation structures as close to them as possible.
 - Topography and landscape structure are often used to identify likely migration and movement routes, for example, continuous forest, valley bottoms and streams.
 - Planning is crucial. Ensure all fauna passages consider the surrounding landscape. For example, access to the passage must be guaranteed in the future.
- d) Integration into the surroundings**
- Fauna passages should be well-connected to the surroundings:
 - By habitat corridors leading towards passages for small animals.
 - Barriers that prevent or hinder animals from reaching fauna passages must be removed.
 - Where other infrastructure elements are located nearby, an integrated approach to defragmentation is required.
- e) Table drain management**
- A number of methods can be employed to mitigate the negative impacts table drains may have on fauna passage, including:
 - Line ditches with concrete to prevent water pooling;
 - Line ditches with boulders to prevent animals entering;
 - Spray roadside with biodegradable herbicide;
 - Slash vegetation; or
 - Concrete roadsides.
 - Of the above mitigation procedures, spraying, slashing and concreting roadsides are least feasible due to cost and requirement for ongoing maintenance. In particular, slashing vegetation should be avoided as regrowth is attractive to fauna.

6.17.2 Aspects that negatively influence the rates of fauna structure use

a) Table drain management

- Road run-off into roadside ditches can lead to water accumulation and vegetation that may attract fauna away from fauna structures and result in roadkill.

b) Vegetation management

- Careful plant selection (in consultation with experts) will either provide or reduce habitat opportunities for fauna.
- Plant selection to be based on the purpose of the planting (for example, preventing birds foraging adjacent to roads or provision of habitat).
- Careful and ongoing maintenance of vegetation is required. Appropriate maintenance intervention levels will ensure objectives of vegetation planting are preserved.
- Regrowth of roadside vegetation (for example, after fire burn-offs in the road reserve new grass shoots may attract macropods to graze) can lead to an increase in macropod roadkills at these sites.
- Plant selection:
 - Flowering plants within close proximity to the road pavement should be trimmed prior to flowering to reduce the presence of foraging birds and possible interactions with vehicles.
 - Sterile grass species can be chosen to avoid the seeds attracting fauna to the roadside.

6.18 Other methods that influence the effectiveness of fauna structures

6.18.1 Education

- Education is of critical importance and must be available to and encouraged for all on-site staff, construction staff, office staff and the community.
 - On-site and construction staff:
 - Ensure staff take due care when removing vegetation and translocating fauna.
 - All on-site staff need to be trained to know what measures to take when rescuing fauna (Refer to Section 9.1: Case Studies: Tugun Bypass).
 - Toolbox talks and 'strip maps' can be used by staff to raise awareness of areas containing important/high populations of fauna or fauna mitigation structures.
 - Community:
 - Appreciation of the community's local fauna is encouraged. This will ensure revegetation, maintenance and other activities can be undertaken with economic and social benefits. Create a 'proud' community.

6.18.2 Lighting

- Purpose:
 - The impact of artificial lighting created by roads is relatively unknown and only occasionally considered in impact studies.
 - Artificial lighting (vehicle and street lights) has numerous negative impacts which have only started to be quantified.
- Fauna groups affected:
 - Nocturnal animals.
 - Diurnal species - sleep patterns disturbed by flashes of light.

- Frogs
 - Become immobilised by headlights and vehicular noise, resulting in roadkill.
 - Can be affected by temporary and permanent changes to lighting in terms of reproduction, foraging, predator avoidance and social interactions.
 - May be blinded by artificial light.
 - Species-specific information:
 - Grey tree frog's ability to hunt and eat was significantly impacted when light illumination was above that of bright moonlight.
 - Several frogs of the Hyla genus are more active between 0.00001-0.001lux, a range well below that on roads. Some only conduct particular calls, such as for breeding and mating, between this range.
- Birds
 - Particularly when migrating, may be attracted to bright lights and become trapped within the circle of light (similar to insects and turtles).
 - Singing and reproductive behaviour of some may be affected.
 - May attempt, unsuccessfully, to nest on streetlights.
- Insects
 - Attract a variety of insects and, in turn, their predators (for example, quolls), resulting in roadkill.
 - May affect signal effectiveness for fireflies.
- Marine turtles
 - Attracted to street lighting when emerging from nests leading to roadkill (Ecological Associates 2002).
- Macropods
 - Pademelons are transfixed by car head lights and suffer from temporary blindness, making them easy targets for predators and increasing chance of vehicle collision.
 - Red-legged pademelons are likely to be attracted to lit areas as they preferentially graze on forest edges.
 - Tammar wallabies are attracted to lit areas.
 - Brush-tailed rock-wallabies are particularly sensitive to light. They have been found to become 'unsettled' on moonlit nights when compared to moonless nights.
- Bats
 - Feeding behaviour may be altered, and result in an increased chance of predation and alteration to their community structure.

a) Vehicle lights

- Head- and tail-lights can be visible up to 90 metres into the forest and further in open areas.
- Cause anxiety for fauna and alienate habitat areas.
- Cause roadkill related to stunning and disorientation effects.
 - The mouse opossum (*Marmosa mitis*) is temporarily blinded by light over 20 lux (car high beam headlights are 20 lux at a ten metre distance) (Wilson and Goosem 2007).
- The general pattern of traffic at night mimics the movement times of nocturnal fauna, that is, heavier movement in the early evening and closer to dawn, which may result in increased rates of roadkill.

Mitigation designs:

- Light barriers:
 - Solid barriers at the base of fences may reduce blindness or stunning caused by headlights (Figure 6.18.1b).
 - Designed to block light from highset head-lights.
 - Consider in sensitive areas (such as wetlands or other breeding grounds).
 - Specifically, on sections of roads bisecting creeks, gullies and other areas purpose-built for fauna connectivity under or above the road (such as underpasses, fauna-friendly culverts, land bridges).
 - Height:
 - At least 1400 mm, depending on topography (may be able to block light from highset headlights).
 - Barriers of the greatest feasible height (likely to be 1600 mm) should be used on down slope sections of road where headlights may sweep over a greater distance.
- Construction of earth berms may be an alternative where general fauna passage needs to be maintained (Figure 6.18.2).
- Smooth bends on roads to decrease light penetration (Figure 6.18.3). However, this may increase the speed environment leading to fauna roadkill.
- Provision of facilities encouraging the use of low beam headlights (for example, fluorescent road marking, reflectors set at short intervals).
- Lower speed limits encourage the use of low beam headlights.
- Create a vegetative barrier of non-palatable species along the roadside (for macropods, refer to Section 7.8 for additional information on palatable species). This requires careful planting and maintenance.



a)



b)

Figure 6.18.1 a) Retention of dense vegetation along the roadside can decrease the effect of vehicle lights on the surrounding environment.
b) Vehicle headlights disturbance can also be minimised by attaching solid barriers to the base of existing fencing along the road.

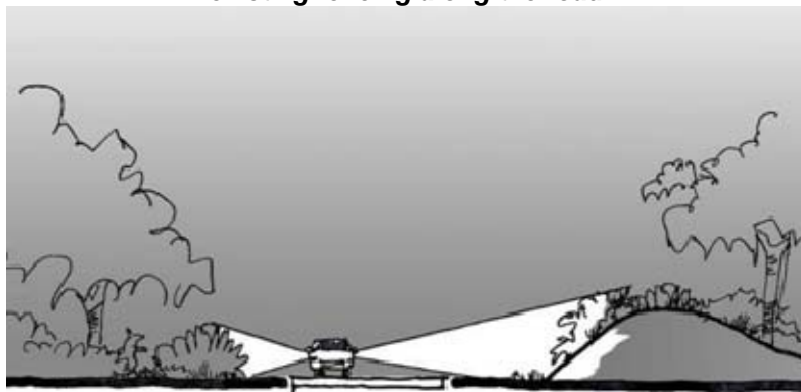
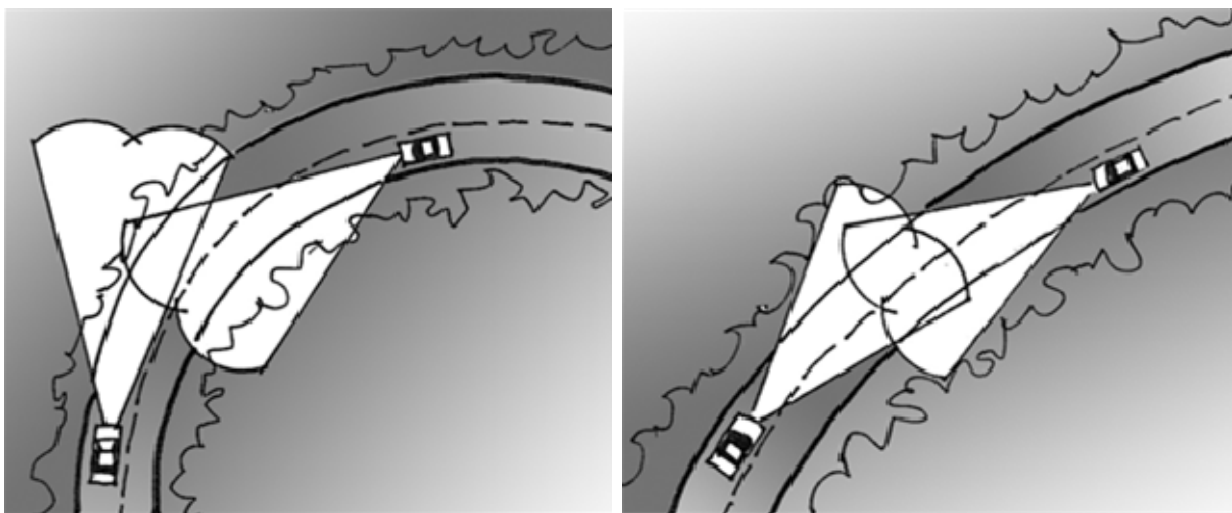

Figure 6.18.2 The use of dense vegetation and earth berms can reduce vehicle light penetration into the surrounding environment.



a)

b)

Figure 6.18.3 Sketches showing the effect of headlights caused by bends in roads.
a) Less optimal sharp bends cause greater light penetration into the surrounding environment.
b) The optional smoother bend, with less illumination of the surrounding environment. Keep speed limits to a minimum to maintain effectiveness.

b) Street lighting

- Traditional lighting can potentially affect fauna's energy budgets through increased stress and changed movement (Figure 6.18.4a).
 - Attracting fauna and possibly even trapping them in an illuminated area; and/or
 - Fauna may actively avoid illuminated areas.
- Ineffective measure for reducing roadkill.
- Reduces habitat quality by illuminating surrounding areas.
- Gliders may avoid crossing in areas which are well-lit but more study is required.
- Lighting adjacent to nesting beaches for marine turtles requires mitigation, as emerging nestlings and breeding females are attracted to lights.

Mitigation:

- Reduce intensity of bulbs and pressure of lamps in streetlights.
- Use low pressure sodium lamps.
- Use fewer streetlights and only where necessary for safety.
- Install shields on streetlights to minimise light spill into neighbouring vegetation and to impede birds establishing nests (Figure 6.18.4b).
- Reduce glare from lighting by using a flat glass aeroscreen instead of a refractor glass cover in streetlights (Wilson and Goosem 2007).
- Use barriers, mounds or dense vegetation to stop light infiltration into surrounding habitat. However, ensure habitat connectivity is maintained (Figure 6.18.4c).
- Decrease height of light poles.
- Use alternatives to lighting such as pavement with light-emitting diodes or fluorescent paint.
 - Increasing the reflectivity of signs and road stripping (retro-reflectivity) can increase visibility for drivers.
- Use lighting that turns on when a car approaches or is at a low illumination level until required (Wilson and Goosem 2007).
- Vegetative Barriers:
 - Vegetation can be used to decrease light penetration from street lighting (Figure 6.18.5).
 - In order to perform as a barrier, a vegetative belt must have sufficient height, length and mass. The mass of the vegetation is based upon its maturity and the type of vegetation.
 - The type of vegetation must be evergreen with dense, leafy growth to limit optical penetrability.
 - Recommendations for planting:
 - Individual plants should be spaced to have sufficient room to develop into mature shrubs.
 - At least two to three rows of dense plantings of tall trees and/or dense shrubs increases effectiveness.
 - Row spacing should be maintained to ensure they do not grow together.

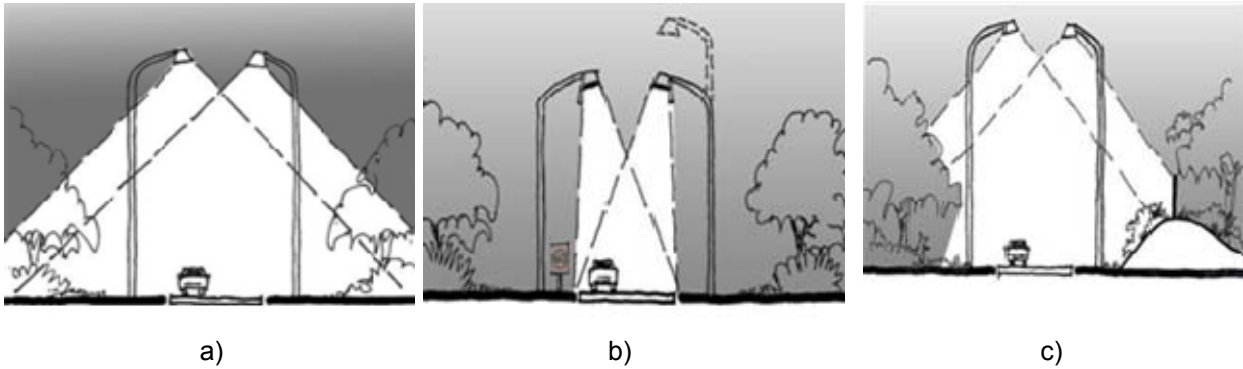

Figure 6.18.4 Effect of traffic light poles on the surrounding environment

a) Traditional lighting methods may penetrate surrounding areas and affect normal fauna behaviour.

This effect can be minimised by:

b) Installing shields on lights;

c) Retaining and/or creating barriers along roadsides

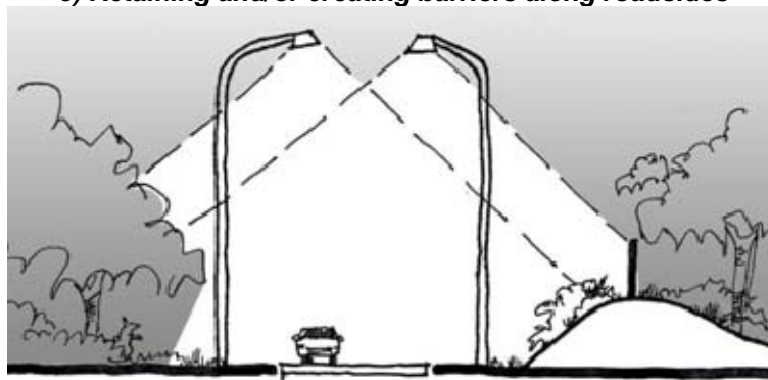

Figure 6.18.5 The use of dense vegetation and earthen berms can reduce vehicle light penetration into the surrounding environment.

6.18.3 Noise

- Most noise from highways is produced by engines and tyres as they contact the surface, with noise varying by tyre and surface qualities.
- Noise from vehicular traffic can be of a level to distort territorial bird song, resulting in difficulties in attracting and keeping females (Reijnen and Foppen 1994).
- Increased predation may occur due to the inability of birds to hear predators (Scherzinger 1979).
- Breeding birds appear to be heavily affected by traffic noise (Forman *et al.* 2003).
- Lower bird density has been correlated to traffic noise.
- Typical noise barrier structures may have negative effects on birds.

Mitigation:

a) Elevation of the road surface, and cuts and fills.

- As most of the noise derives from the road surface a change in the elevation and/or the type of road surface may reduce noise. Cuts and fills can be used to advantage.

b) Solid barriers

- Noise wall barriers are commonly constructed in urban situations along highways and high traffic volume roads using materials such as timber, concrete and steel panels, concrete block and toughened glass (Figures 6.18.6 to 6.18.8).

- While this effectively reduces noise in lower vegetation layers, it also eliminates permeability for many terrestrial fauna groups, reduces light penetration at low levels and is expensive.
- TMR guidelines provide information on planting in conjunction with solid noise walls:
 - Re-planted vegetation: a minimum of three-quarters the height of the barrier; vegetation should be stratified (i.e. start with groundcover, shrubs, small trees and then larger trees against the barrier) and extend from the barrier at least 1.5 times the height of the barrier (Queensland Department of Main Roads 2004).
- Considerations of transparent noise wall barrier (Figure 6.18.8).
 - Birds have trouble seeing transparent noise walls and this can result in bird strikes.
 - Constructed from acrylic or glass.
 - Install glass that is treated with a UV reflective coating. Glass coated in UV- reflective coating is clearly visible to birds and virtually transparent to humans (Ambrose 2008).
 - Embed mesh in acrylic transparent noise walls.
 - This treatment stops bird strike and does not disturb the driver's view.
 - Lines should be 50 mm apart if oriented horizontally, and 100 mm if oriented vertically.
 - Horizontal line etchings, five centimetres apart on clear noise wall barriers is the optimal treatment to avoid bird strikes and minimise disturbance to drivers (Figure 6.18.8b).
 - Other markings on noise walls have also been used (Figure 6.18.7).



Figure 6.18.6 Solid noise wall barrier (Taylor 2008).



Figure 6.18.7 Transparent noise wall with etchings to reduce bird strike along the Tugun Bypass (Taylor 2008).

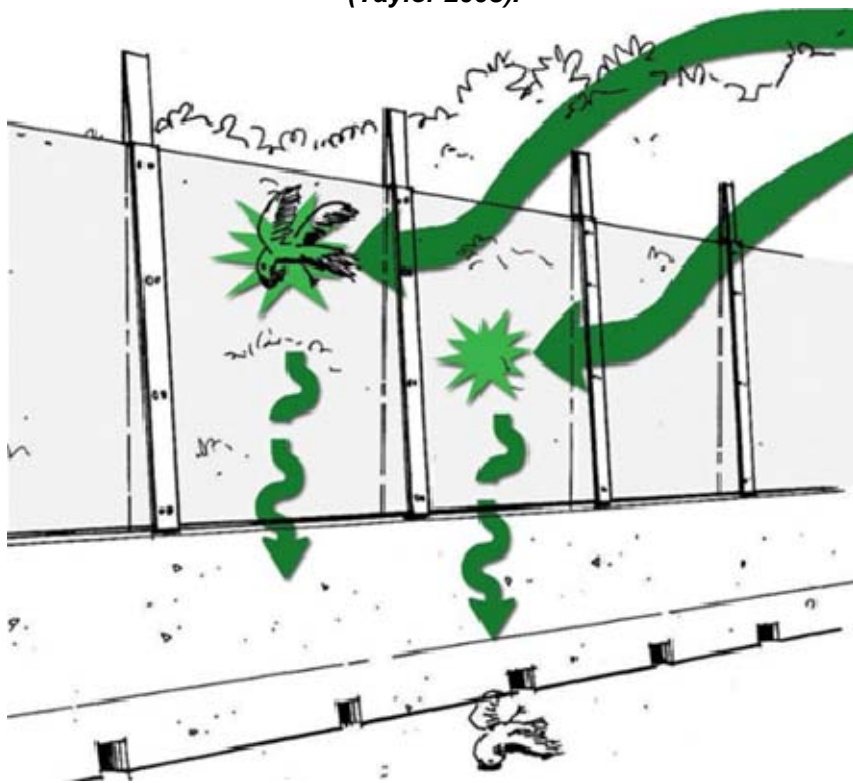

a) Transparent noise wall design without consideration of potential bird strike.

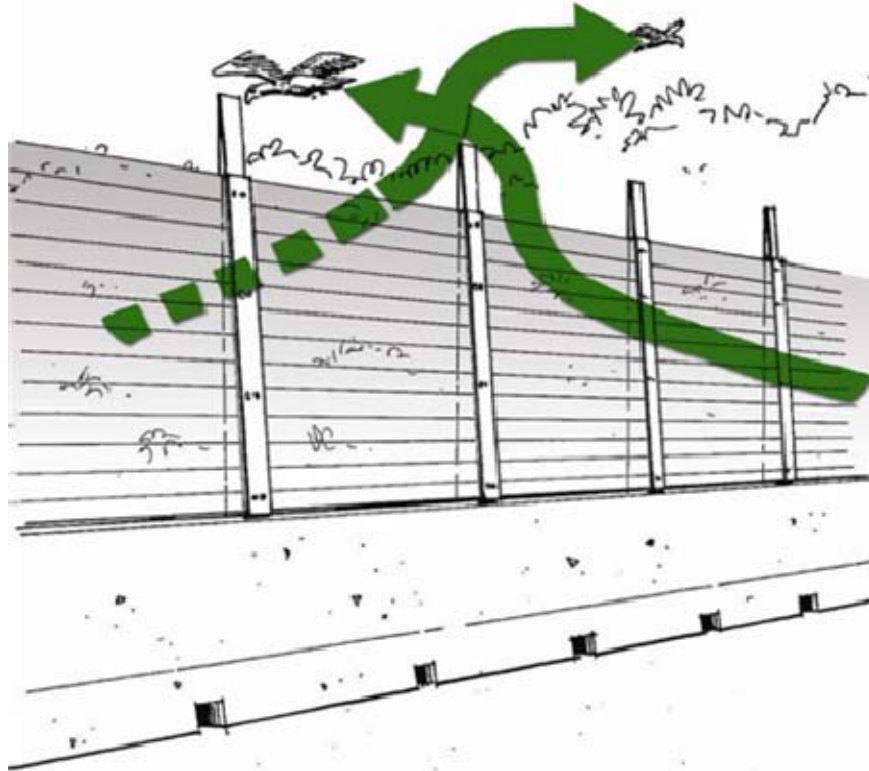

b) Transparent noise wall design with horizontal etchings incorporated to minimise bird strike.

Figure 6.18.8 Transparent noise wall barriers need to consider the issue of bird strike.

c) Vegetative barriers

- Vegetation can be used as an alternative noise (and light) abatement measure when substantial reductions in noise levels are not required (Figure 6.18.9).
- In order to perform as a barrier, a vegetative belt must have sufficient height, length and mass. The length and height requirements are analogous to those of a conventional freestanding noise wall (Harris 1986).
- The mass of the vegetation is based upon its maturity and the type of vegetation.
- The type of vegetation must be an evergreen with dense, leafy growth that will limit optical and sound penetrability.
- Recommendations for planting:
 - Individual plants spaced to ensure sufficient room for the development of mature shrubs.
 - At least two to three rows of dense plantings of tall trees and/or dense shrubs increases effectiveness.
 - Correct row spacing to be maintained, ensuring rows do not grow together.
- Vegetative barriers will not provide the same noise reduction as a free standing noise wall.
- For a vegetative barrier to provide a 3dB reduction, it needs to be at least 30 metres wide and 4.6 metres high (depending on the type of planting and maintenance).
- Effectiveness is dictated by the planting scheme and the maintenance schedule.
- Consider dense vegetation where noise walls would cause a greater level of disturbance and fragmentation than a dense hedge of vegetation.

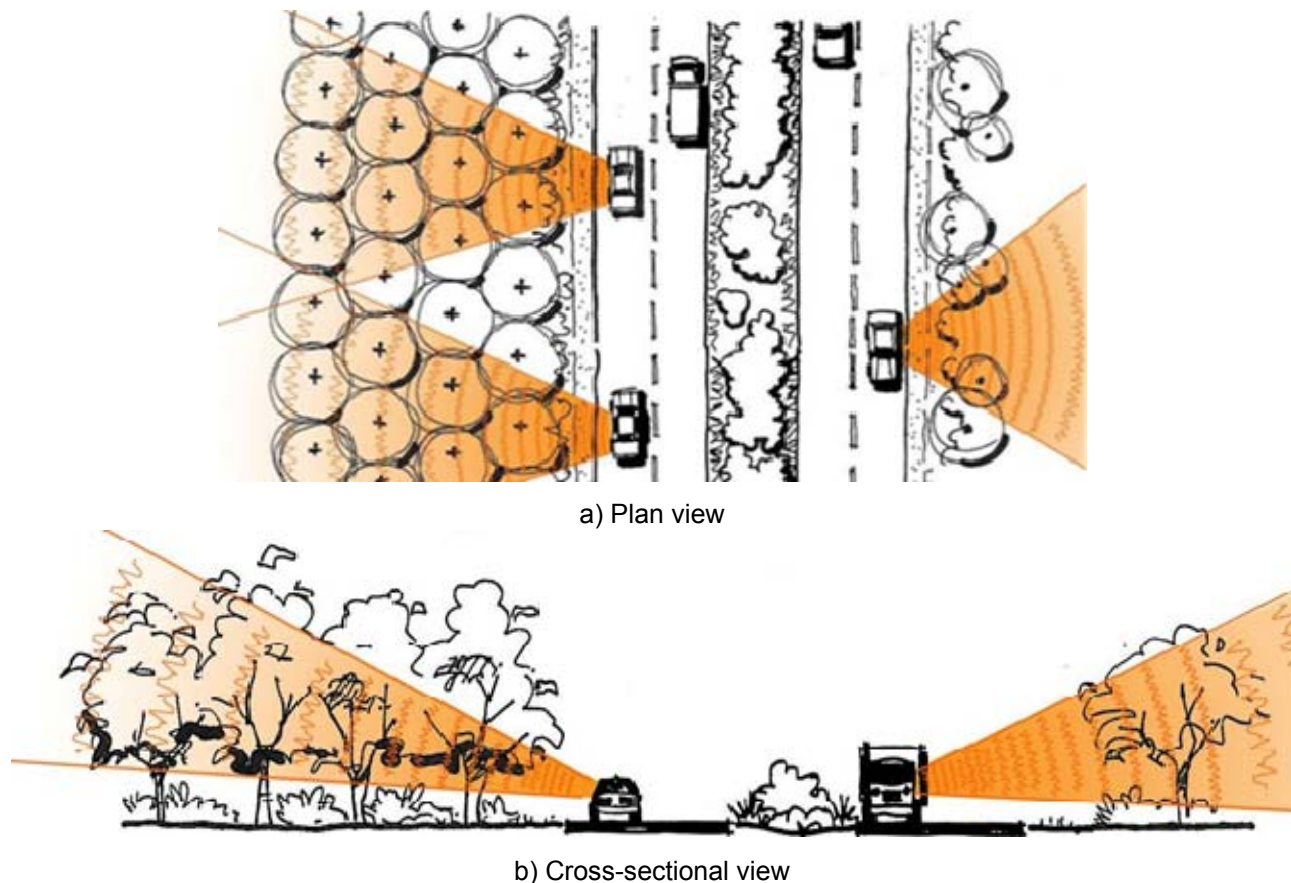

Figure 6.18.9 Drawing highlighting the effectiveness of vegetation as a noise barrier.

d) Road surface

- Smooth surfaces have been developed to reduce noise while retaining safe traction control; in addition some tyres are less noisy than others. Road authorities need to consider road surface design when upgrading or constructing highways.

6.18.4 Design Speed

A reduction in road speed may be a cost effective way to reduce fauna roadkill.

6.18.5 Road Safety Barriers

Road safety barriers potentially increase road mortality by trapping fauna on the road.

Safety barrier design may need to be modified to enable fauna to climb over or under such structures.

Temporary structures may be attached to these barriers to assist fauna to pass over these structures.

Plastic Road Safety Barriers:

To enable fauna to cross under the barrier, a 400 mm x 400 mm arch cut-out at the base is suggested.

- Every second barrier requires a cut-out.
- Smaller size cut-outs currently prohibit use by large koalas (Queensland Department of Main Roads 2009).

Can be modified by placing plastic mesh (parawebbing) or wooden planks on the sides of these barriers. This assists koalas to climb over the barriers and may also prove useful for some small mammal species (although untried for the latter fauna group) (Figures 6.18.10 and 6.18.11).

The current forklift holes within these barriers may provide some level of permeability for small mammals depending on climbing capabilities.

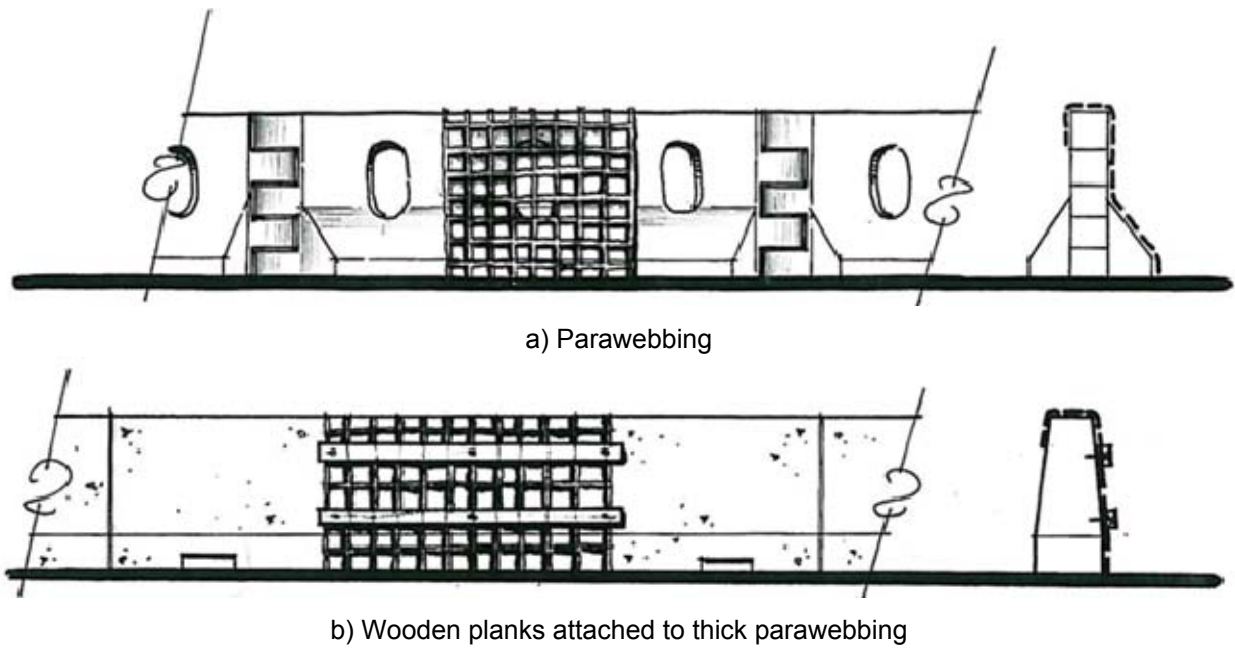

Figure 6.18.10 Modifications that can be placed over barriers to assist fauna to more easily escape road corridors.



Figure 6.18.11 Koala barrier trial at the Australian Wildlife Hospital, Queensland. Some koalas were able to use parawebbing to climb over the barrier (Scott 2008).

Concrete Safety Barriers:

To enable fauna to cross over concrete barriers wooden poles placed horizontally along barriers may be installed.

- o Maximum of 500 mm apart to suit koalas' reach.

Can also be modified by placing plastic mesh (parawebbing) or wooden planks on the side of these barriers. This may assist koalas to climb over the barriers.

Currently studies indicate that modifications may still be inadequate to enable safe fauna passage (Figure 6.18.12).



Figure 6.18.12 Koala barrier trials at the Australian Wildlife Hospital in Queensland. This koala was able to use wooden logs to climb over the simulated concrete barrier (Scott 2008).